



**Fugro Intersite Ltd**

# **User Manual**

## **MultiFix 5**

© Copyright 2006 Fugro Intersite Ltd

Dated: November 2006

**AMENDMENT RECORD SHEET**

<b>Issue</b>	<b>Date</b>	<b>Reason for change</b>	<b>Revised by</b>	<b>Authorised</b>
0	26/10/05	Initial Release	R. Hayles	



<b>Document No.</b>	
<b>Filename</b>	MultiFix - New
<b>Distribution</b>	MultiFix Users

Contents	Page No
SECTION	
1. MULTIFIX SUITE ZERO APPLICATION RESUME .....	8
2. SOFTWARE INSTALLATION .....	9
2.1. MULTIFIX SUITE PROGRAMS .....	9
2.2. DONGLE DRIVERS/LICENSE KEY .....	9
2.3. DIGIBOARD DRIVERS .....	9
2.4. PRE-CONFIGURATION .....	11
2.4.1. Comms Profile.....	12
2.4.2. Output Pre-Selection.....	12
3. MULTIFIX 5 PROGRAM .....	15
3.1. MULTIFIX 5 INTRODUCTION .....	15
3.2. CONFIGURATION .....	16
3.2.1. Skyfix Single Frequency.....	16
3.2.2. Skyfix XP / Premier - Dual Frequency .....	17
3.2.3. Hardware Requirements .....	18
3.2.4. GPS Receiver Configurations .....	20
3.2.4.1. Ashtech (Thales Navigation) Receivers.....	20
3.2.4.1.1. Configuration from within MultiFix.....	20
3.2.4.1.2. Ashtech Evaluate Configuration .....	21
3.2.4.1.3. Ashtech Z-Family .....	23
3.2.4.1.4. Ashtech DG16.....	24
3.2.4.1.5. Ashtech G12 .....	25
3.2.4.1.6. Ashtech GG24 .....	26
3.2.4.2. Trimble Receiver Configuration .....	27
3.2.4.2.1. Trimble BD112 .....	27
3.2.4.2.2. Trimble DSM .....	28
3.2.4.2.3. Trimble DSM212 .....	28
3.2.4.2.4. Trimble DSM232 .....	28
3.2.4.2.5. Trimble SK8 .....	28
3.2.4.2.6. Trimble MS750.....	28
3.2.4.2.6.1. Front Panel Configuration .....	29
3.2.4.2.6.2. MultiFix "Yellow Box" Remote Configuration...	31
3.2.4.2.7. Trimble BD750 .....	32
3.2.4.2.8. Trimble 5700 .....	32
3.2.4.2.9. Trimble 4000DS .....	35
3.2.4.2.10..... Trimble 4000 SSE	37
3.2.4.2.11..... Trimble 4000 SSi	39

3.2.4.3.	NovAtel Receivers.....	42
3.2.4.3.1.	NovAtel Millennium .....	42
3.2.4.3.1.1.	Communicating with the NovAtel Millennium OEM Card	42
3.2.4.3.1.2.	Configuring the NovAtel Millennium from within MultiFix	45
3.2.4.3.2.	NovAtel OEM4 .....	46
3.2.4.3.2.1.	Communicating with the NovAtel OEM4 Card	46
3.2.4.3.2.2.	Configuring the NovAtel OEM4 from within MultiFix	48
3.2.4.4.	Topcon Receivers .....	49
3.2.5.	MultiFix Files .....	49
3.2.6.	To Run MultiFix .....	51
3.3.	REAL TIME OPERATION .....	51
3.4.	THE TOOL BAR .....	51
3.4.1.	File.....	53
3.4.1.1.	New .....	53
3.4.1.2.	Open.....	53
3.4.1.3.	Save .....	54
3.4.1.4.	Save As .....	55
3.4.1.5.	Exit .....	55
3.4.2.	Logging.....	55
3.4.2.1.	Zero.....	55
3.4.2.1.1.	Edit.....	56
3.4.2.1.2.	Starting, Stopping and Pausing .....	57
3.4.2.2.	Rinex.....	57
3.4.2.2.1.	Edit.....	58
3.4.2.2.2.	Edit Header .....	59
3.4.2.2.3.	Starting, Stopping and Pausing .....	61
3.4.3.	Configure.....	61
3.4.3.1.	IO.....	61
3.4.3.1.1.	Comm .....	61
3.4.3.1.2.	Sockets .....	62
3.4.3.1.2.1.	The MultiFix Computer as a TCP Client.....	63
3.4.3.1.2.2.	The MultiFix Computer as a TCP Server .....	65
3.4.3.1.2.3.	Datagrams .....	66
3.4.3.2.	GPS Receiver .....	67
3.4.3.3.	Starfix Decoder .....	69
3.4.3.3.1.	New.....	69
3.4.3.3.2.	Editing and Deleting.....	74
3.4.3.4.	Calculations.....	74

3.4.3.4.1. Settings .....	74
3.4.3.4.2. Skyfix XP.....	77
3.4.3.4.3. New Calculation.....	79
3.4.3.4.4. Editing and Deleting.....	81
3.4.3.5. Output.....	81
3.4.3.5.1. Standard Outputs.....	82
3.4.3.5.2. Approved NMEA Sentence Outputs .....	83
3.4.3.5.3. User Modified NMEA Sentences .....	84
3.4.3.5.4. UTM Outputs.....	88
3.4.3.5.5. Editing and Deleting.....	89
3.4.3.6. P2/94 Output .....	89
3.4.4. Action .....	91
3.4.4.1. Restart Sockets.....	91
3.4.4.2. Collect Almanac .....	91
3.4.4.3. Update Differential Stations .....	92
3.4.4.4. Reset SkyFix XP Filter .....	93
3.4.4.5. Configure TSIP.....	93
3.4.4.5.1. Default TSIP Configuration.....	93
3.4.4.5.2. Advanced_TSIP_Configuration .....	93
3.4.4.6. Configure GPS Receiver.....	95
3.4.4.6.1. Default Receiver Configuration.....	96
3.4.4.6.2. Advanced Receiver Configuration .....	96
3.4.4.7. SV Status .....	97
3.4.4.8. Force P294 Ephemeris/Almanac Update.....	97
3.4.5. View.....	97
3.4.5.1. Files.....	99
3.4.5.2. Work Area .....	99
3.4.5.3. Input/Output .....	100
3.4.5.3.1. Status.....	101
3.4.5.3.2. Sockets .....	101
3.4.5.3.3. Datagrams .....	102
3.4.5.3.4. Scroller.....	102
3.4.5.3.5. GPS Receiver .....	104
3.4.5.3.6. RTCM Input.....	104
3.4.5.3.7. Output Strings.....	105
3.4.5.4. GPS.....	106
3.4.5.4.1. Receiver.....	106
3.4.5.4.2. SNR .....	106
3.4.5.4.3. Scintillation Meter .....	107
3.4.5.4.4. Code Carrier (CCF) .....	109
3.4.5.4.4.1. Summary .....	109

3.4.5.4.4.2. Time Series .....	111
3.4.5.4.4.3. SNR Weight.....	113
3.4.5.4.5. Iono Filter .....	114
3.4.5.4.5.1. Summary .....	114
3.4.5.4.5.2. Time Series .....	114
3.4.5.4.6. Ephemeris.....	115
3.4.5.4.7. Almanac.....	115
3.4.5.4.8. Clock.....	118
3.4.5.4.9. Measurements .....	119
3.4.5.5. Corrections.....	120
3.4.5.5.1. Orbit Data.....	120
3.4.5.5.1.1. Time Series .....	120
3.4.5.5.1.2. Data Table .....	121
3.4.5.5.2. DGPS Data .....	123
3.4.5.5.2.1. Station .....	123
3.4.5.5.3. Performance .....	124
3.4.5.5.3.1. Time Series .....	126
3.4.5.5.4. Starfix Decoder .....	127
3.4.5.5.4.1. Table.....	127
3.4.5.5.4.2. History .....	128
3.4.5.5.4.3. Constellation.....	129
3.4.5.5.5. Latency .....	130
3.4.5.5.6. Type 16.....	132
3.4.5.5.7. Starfix Beams.....	133
3.4.5.6. Calculations.....	134
3.4.5.6.1. Status.....	134
3.4.5.6.2. Positions .....	136
3.4.5.6.3. XP Offsets.....	137
3.4.5.6.4. Offsets.....	137
3.4.5.6.5. Residuals .....	139
3.4.5.6.6. UKOOA Stats.....	141
3.4.5.6.7. Time Series Plots.....	144
3.4.5.7. Event Log .....	149
3.4.6. Options.....	151
3.4.6.1. Lock.....	151
3.4.6.2. Colour.....	151
3.4.6.3. Hide Tool Bar .....	152
3.4.6.4. Autostart.....	152
3.4.6.5. Trial Point Warning.....	152
3.4.6.6. Rinex.....	153
3.4.6.7. Type 16 Alert.....	153

3.4.6.8. Event Logger.....	153
3.4.6.9. Replay.....	154
3.4.6.10. ....	P294
154	
3.4.7. Tools.....	154
3.4.7.1. Position Viewer Wizard.....	154
3.4.7.2. Save Almanac to File.....	158
3.4.8. Windows.....	158
3.4.8.1. Tile.....	158
3.4.8.2. Close All.....	158
3.4.8.3. The Open Windows.....	158
3.4.9. Help.....	159
3.4.9.1. Performance.....	159
3.4.9.2. About.....	160
3.4.9.3. Update/View License.....	160
3.5. MULTIFIX REPLAY.....	162
3.5.1. MultiFix Replay.....	162
3.5.2. Replay options.....	163
4. APPENDICES.....	164
4.1. APPENDIX A - DATA OUTPUT STRINGS.....	164
4.1.1. Appendix A - Data Output Strings.....	164
4.1.2. NMEA GGA Sentence.....	164
4.1.3. GGA (LDA).....	165
4.1.4. GGA (SLV).....	165
4.1.5. NMEA GSA Sentence.....	165
4.1.6. NMEA GST Sentence.....	166
4.1.7. NMEA GSV Sentence.....	167
4.1.8. NMEA GSU Sentence.....	168
4.1.9. NMEA VTG Sentence.....	168
4.1.10. NMEA GLL Sentence.....	169
4.1.11. RTK Sentence.....	169
4.1.12. NMEA ZDA Sentence.....	170
4.1.13. NMEA RMC Sentence.....	170
4.1.14. NMEA UKOOA / IMCA DP Sentence.....	171
4.1.14.1. .... NMEA UKOOA/IMCA DP Sentence	
171	
4.1.14.2. .... DGPS Quality Indicator	
172	
4.1.15. DNAVN Output Format.....	173
4.1.16. DNAVN Nautis Modification.....	174
4.1.17. TRIMBLE Output Format.....	175

- 4.1.18. ZEROLINK ..... 176
- 4.1.19. Fugro UKOOA Output Format ..... 176
- 4.1.20. GECO UKOOA Output Format ..... 178
- 4.1.21. GECO UKOOA Version 2 Output Format..... 179
- 4.1.22. Fugro XP Expanded Output Format ..... 180
- 4.1.23. Fugro XP Concise Output Format ..... 184
- 4.1.24. Fugro Corrections ..... 186
- 4.1.25. UTM / SYLEDIS ..... 187
- 4.1.26. UTM / GEM 80P ..... 188
- 4.1.27. NMEA GSU Sentence ..... 188
- 4.1.28. DGPS-IS ..... 188
- 4.2. APPENDIX B - UNDERSTANDING SCINTILLATION ..... 189
  - 4.2.1. Appendix B - Understanding Scintillation ..... 189
  - 4.2.2. Detecting Scintillation ..... 191
  - 4.2.3. Combating Scintillation ..... 192
  - 4.2.4. Scintillation of the Data Links ..... 193
- 4.3. APPENDIX C - STATIC POSITION OFFSET FILE ..... 194
- 5. GLOSSARY ..... 196



# 1. MULTIFIX SUITE ZERO APPLICATION RESUME

There are 10 applications available in the MultiFix group.

1. **MultiFix** is the core module to the zero suite. MultiFix performs all of the required GPS and **DGPS** calculations necessary to generate a position. MultiFix also includes extensive real-time QC analysis tools.
2. **Soccer** is an application allowing routing and monitoring of data between COM ports and sockets. The routing is via virtual ribbons. Data can be received on COM ports or Sockets and then routed through to multiple other COM ports or Sockets. Soccer can also be used as text logger, either logging to a text file, or logging simultaneous data, from multiple ports, for replay through LogPump.
3. **SkyLink** is an **RTCM** transfer/modification program, which can be used to apply Ionospheric corrections to Type 1 RTCM messages before outputting to DGPS firmware / software, that can not of itself derive a lono-free solution of position.
4. **Qual 2** is a real time static position quality monitor application.
5. **LogPump** is an application for reading data originally logged by any zero program and then outputting that data to virtual ports, allowing the data to be replayed in any application.
6. **Position View** is a real time application either for comparing dynamic position sources against a static point position or for comparing position sources by using one of them as the reference. Position View can also select and output the most stable positioning source for output to another application, such as a single port DP system.
7. **RxV**, or Receiver Verify, is an add on to MultiFix that allows the software to use multiple GPS receivers in a single solution. This is intended for use aboard vessels where obstruction of the GPS antenna is common, such as aboard construction barges and jack up rigs.
8. **Brunei** is a customised application specifically for the Brunei Shell VTS project.
9. **Input Status Monitor** is an application that provides the user with the ability to monitor the status of all inputs.
10. **GeoSky** is a GPS and Reference station mission planning tool.

## 2. SOFTWARE INSTALLATION

### 2.1. MULTIFIX SUITE PROGRAMS

The MultiFix program can be installed from a stand-alone setup.exe contained on the MultiFix Software CD, or direct from the MultiFix support team in Great Yarmouth.

### 2.2. DONGLE DRIVERS/LICENSE KEY

MultiFix requires a dongle or a [License Key](#) to run the program.

Dongle facility is retained for existing dongle users only, no new dongles will be issued.

To obtain a [License Key](#), please contact your local Operating Company.

The three different MultiFix position calcs are as follows. Each requires a separate licence:

- **L1** - (Differential GPS) standard single frequency position calculation. It allows the user to generate a position either completely standalone (with only a receiver) or to calculate a single frequency DGPS solution using RTCM correction data received via a communications link.
- **L1/L2** - similar to above but using dual frequency RTCM DGPS corrections which allows for ionospheric errors to be removed. This is useful in areas of high ionospheric delay such as equatorial areas. It is not necessarily better accuracy than single frequency DGPS in all locations but where there is a lot of ionospheric activity it will outperform single frequency DGPS.
- **SkyFix XP** - this is an 'orbit corrected' solution equivalent to Starfix GSS. Satellite ephemeris correction data is broadcast via satellite links and used by MultiFix to produce decimetre accuracy position solutions.

### 2.3. DIGIBOARD DRIVERS

To install **Digiboard** drivers click the relevant button for the Windows operating system under which the program is to run.

The Digi drivers for Windows 2000 are part of the Windows 2000 operating system.

The example that follows is for Windows NT with a PC/8e Digiboard:

1. Click the arrow button in section 1 of "Device Driver Installation".

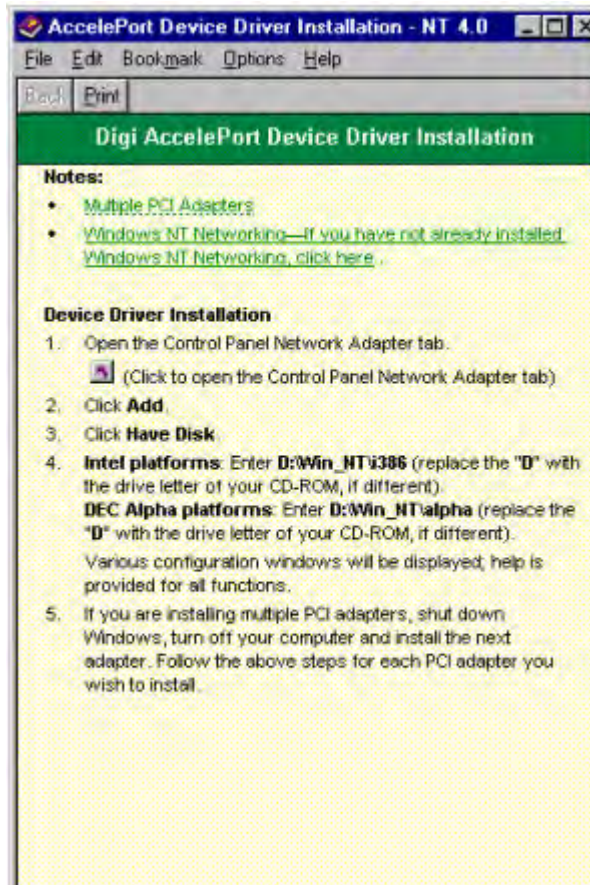

2. In the Networks dialogue, click **[Add...]**
3. In the Select Network Adapter dialogue, click **[Have Disk...]**.
4. In the Insert Disk dialogue type in the CD-ROM drive letter followed by \Win\_nt\i386, e.g. D:\Win\_nt\i386.
5. In the Select OEM Option dialogue highlight the Digiboard installed in the computer, for example "Digi PC/8e(ISA) Adapter", click **[OK]**.
6. In the Digiboard Adapter dialogue, check the "IO base port" and the "Memory base address". In the case of the PC/8e board, the "IO base port" number is set by the DIP switch settings, see diagram below. The "Memory base address" for a PC/8e is typically D0000. Click **[OK]** to exit.

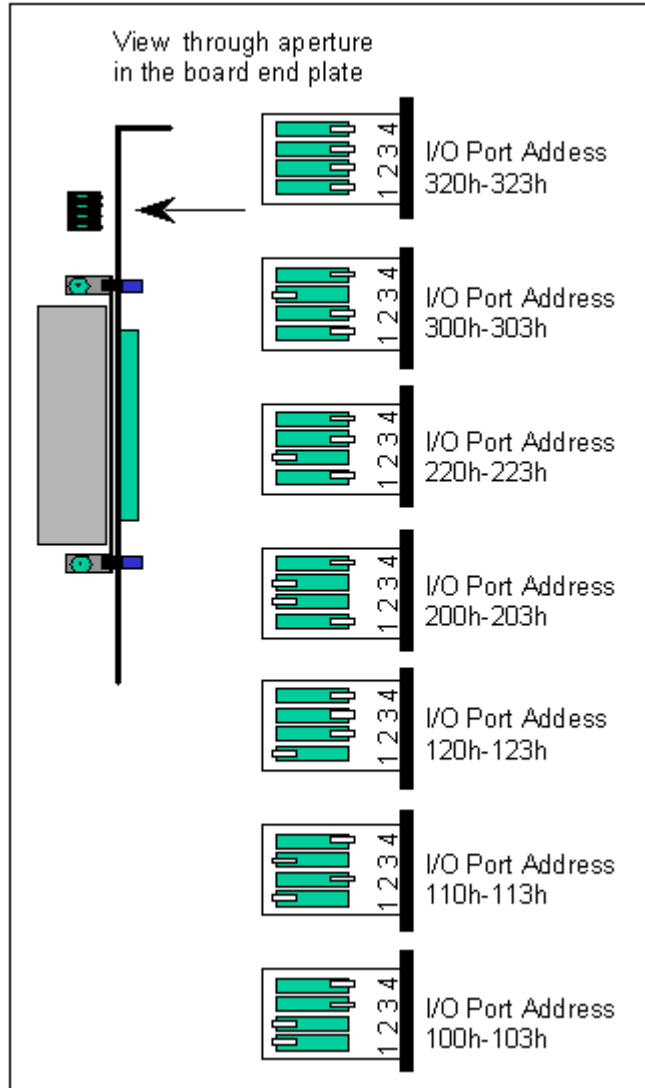

7. **[Close]** the Network dialogue and as requested restart the computer.

The Digiboards must be mapped to the COM ports. The first Digiport should be numbered 1 higher than the in built ports in the computer.

## 2.4. PRE-CONFIGURATION

Assuming data is being input and or output via COM ports, before MultiFix is run it is necessary to let the program know what COM ports are available.

Likewise, assuming position data outputs will be required from MultiFix the program needs to know the how to build those output messages. To do that, \*.zpo output library files must be selected.

To accomplish both the above tasks, access the MultiFix Vx.xx IO Configuration Control Panel by selecting “Start” \ “Programs” \ “MultiFix 5 Vx.xx” \ “Configure IO”

The MultiFix IO Configuration dialogue has two tabs.

- [Comms Profile](#)
- [Output Pre-Selection](#)

### 2.4.1. Comms Profile

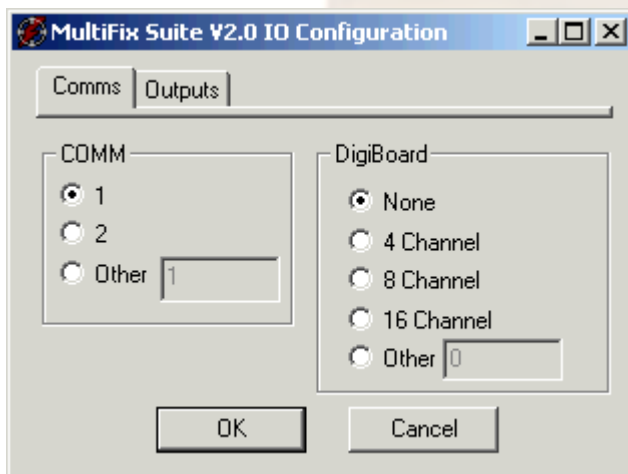

Click the relevant radio buttons to indicate what COM ports and Digiboards are available to the program and then exit using **[OK]**.

### 2.4.2. Output Pre-Selection

This tab is only required for use in MultiFix. To create output strings MultiFix needs access to \*.zpo library files. There are four output options included for general distribution, two of which are pre-selected. Each of these options are linked with the appropriate ZPO file.

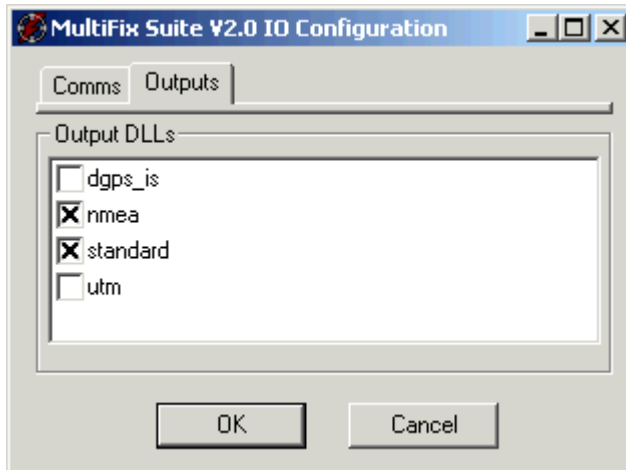

The **NMEA** output option enables MultiFix to create:

- GGA,
- GGA + VTG,
- GLL,
- **RTK** and
- ZDA sentences.
- DPGGA
- GSA
- GST
- GSV
- GSU
- GGA (LDA)
- GGA (SLV)

The STANDARD option enables MultiFix to create,

- Trimble
- DNav
- **ZeroLink**
- Fugro TGS UKOOA
- Geco UKOOA and
- Geco UKOOA Version 2 messages
- Fugro XP Expanded and
- Fugro XP Concise messages
- Fugro Corrections

The **UTM** option allows MultiFix to create the Syledis and GEM 80 DP outputs. The DGPS\_IS option is a development tool and not required for standard work.

Two options, NMEA and STANDARD options are pre-selected by default. To add the UTM or DGPS\_IS outputs check the appropriate boxes.

The set up of various outputs is covered in [Configure/Output](#). The format of the messages can be found in [APPENDIX A - DATA OUTPUT STRINGS](#).

**NOTE** that the “Automatically adjust clock for daylight saving changes” option in the “Time Zone” tab under “Start” \ “Settings” \ “Control Panel” \ “Date/Time” should NOT be checked.

---

## 3. MULTIFIX 5 PROGRAM

### 3.1. MULTIFIX 5 INTRODUCTION

MultiFix 5 is a Fugro fifth generation differential **GPS** real time position computation and QC program. ***MultiFix 5 builds on MultiFix 4 with the introduction of a new improved version of the Skyfix XP engine.***

MultiFix takes in ***Almanac, Ephemeris***, Raw Code and Carrier measurements from either a single or a dual frequency GPS receiver (or from logged files for replay purposes).

It also inputs ***RTCM*** SC104 Version 2 differential correction messages from one or more RTCM Correction delivery systems, and Fugro Proprietary RTCM Type 55 Ionospheric range corrections. These are generated at selected Starfix Plus reference stations and broadcast via the Fugro global network of high and low power L Band beams.

- There is no limit on the number of RTCM correction delivery systems.
- There is no limit on the number of RTCM differential reference stations.
- There is no limit on the number of computations.
- Each computation can employ corrections from any combination of reference stations available.
- The computations are weighted least squares with statistical evaluation based upon the ***UKOOA*** recommendations.
- There is no limit on the number of outputs.
- There is no limit on the number of view windows.
- The view windows can be customised.

MultiFix has been designed in a modular fashion such that data is passed between modules as if over a computer network. The core module MultiFix performs the computation of the GPS antenna position. Additional modules are available with more to be made available in the future. While a single computer can be used, the various modules will equally be able to be run on different computers provided there is a network interconnection.

MultiFix uses the ***EGM96 geoid***/spheroid separation model.



The RTCM corrections that are generated at reference stations are contaminated by a variety of error components, one of which is Ionospheric delay. The Ionospheric delay is currently more variable because of greater sun spot activity. MultiFix's standard computation uses the Klobachar Ionospheric delay model. This model is updated periodically but is not responsive to the current short-term variability. MultiFix has an additional calculation option when working with dual frequency receivers and when in receipt of Type 15 or 55 RTCM messages. With dual frequency receivers, estimates can be made of the Ionospheric delay by examining the differences between the measurements from the two frequencies. If the same procedure for estimation of Ionospheric delay is performed at the reference stations and on the mobile, both the RTCM corrections and the pseudo-ranges can have the Ionospheric delay removed, effectively providing an Ionospheric-Free DGPS position solution.

The text in this manual conforms to certain conventions

1. All command buttons are shown bold and bracketed with square brackets e.g. **[OK]**,
2. When a keyboard key is represented, it is shown bold and bracketed by greater than and lesser than symbols e.g. **<spacebar>**.
3. Direct quotations from dialogues or edit control slots are shown in normal text in quotations, e.g. "IO Channel:"
4. Hyperlinks are shown as [underlined blue](#).
5. Terms in the glossary are shown as ***brown***.

## 3.2. CONFIGURATION

### 3.2.1. Skyfix Single Frequency

The following diagrams outlines the hardware requirements and interconnections for a *SkyFix L1* single-frequency set up using Fugro MK3 or MK5 decoders and an Ashtech DG16 **GPS** receiver.

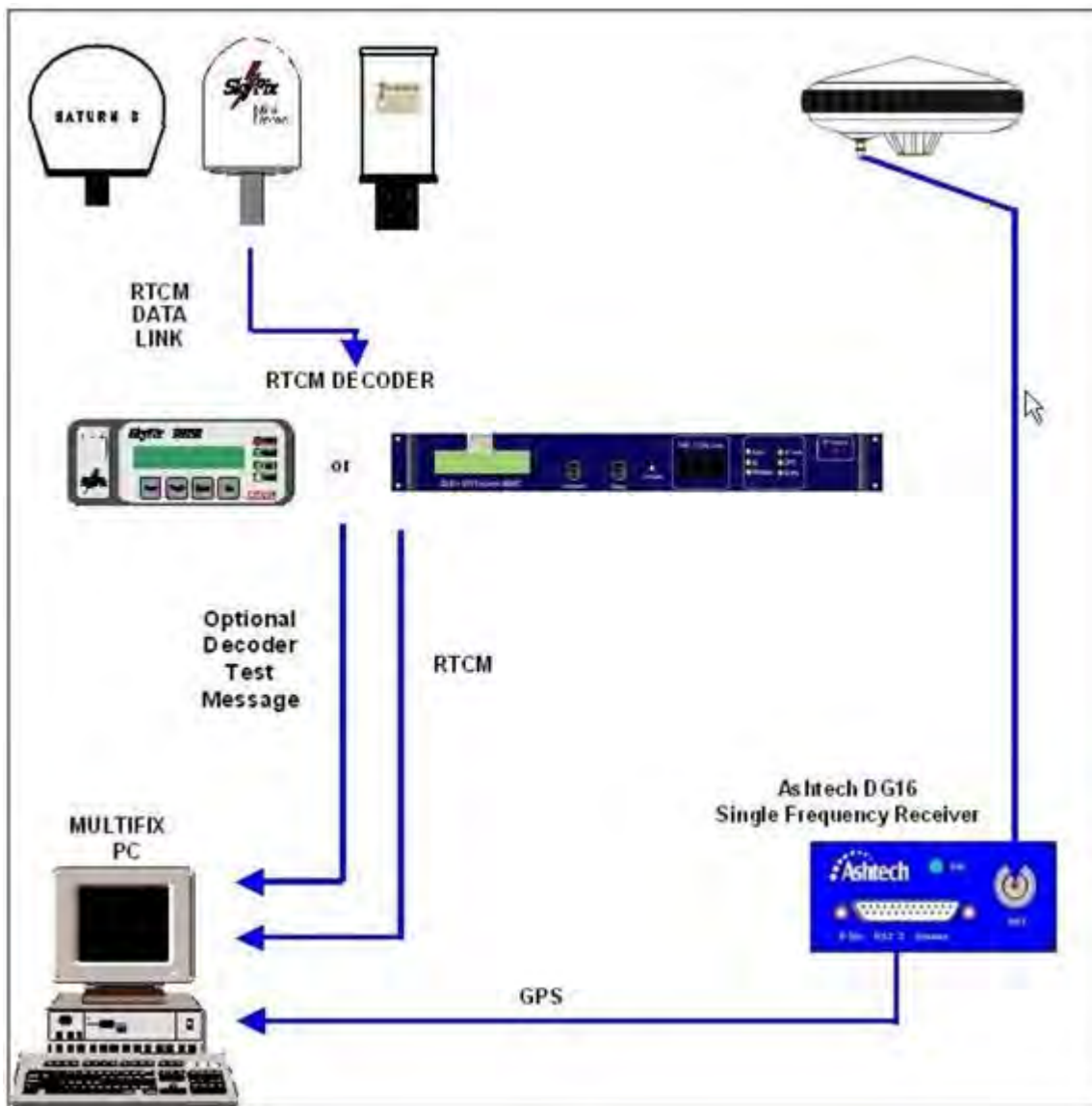

### 3.2.2. Skyfix XP / Premier - Dual Frequency

The following diagrams outlines the hardware requirements and interconnections for a *SkyFix XP* or *L1/L2* dual-frequency set up using an Ashtech ZX Sensor or Trimble MS750 receiver.

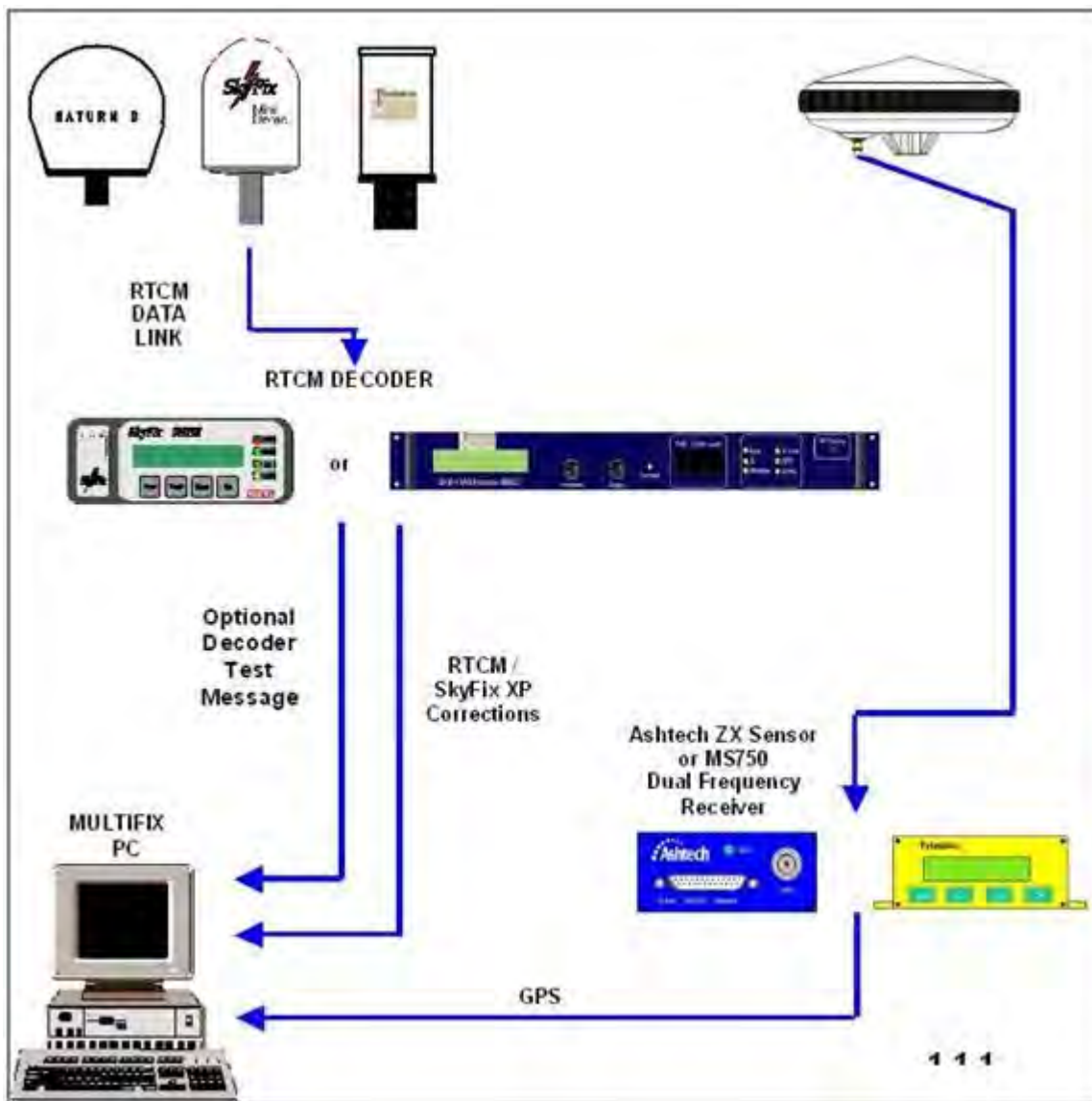

Although not shown above, other configurations are supported where the *RTCM* decoder has a *GPS* receiver board fitted. MultiFix is then able to take the *GPS* measurement and other data as well as the *RTCM* correction from the Decoder.

### 3.2.3. Hardware Requirements

MultiFix requires the following:

A PC running Windows NT, Windows 2000 and Windows XP. The minimum recommended PC is a 600MHz Pentium III (or equivalent) processor with 128 MB RAM. A graphics resolution of at least 1024 by 768 pixels is advised in order to achieve maximum clarity of all the graphics displays. If two copies of MultiFix are to be

run on the same machine, or if more than 15 reference stations are used, then it is recommended to have a minimum of 256MB RAM.

For the installation of the software the PC requires a CD-ROM drive.

MultiFix needs a single frequency **GPS** receiver to run in *SkyFix L1* mode and a dual frequency GPS receiver to run in dual frequency *SkyFix L1/L2* or *SkyFix XP* mode.

MultiFix supports the following GPS receivers:

<b>Manufacturer</b>	<b>Model</b>	<b>Type</b>	<b>Baud Rate (Minimum)</b>	<b>Baud Rate (Recommended)</b>
<b>Ashtech (Thales Navigation)</b>	<b>Z Family</b>	<b>Dual</b>	<b>38400</b>	<b>57600</b>
<b>Ashtech (Thales Navigation)</b>	<b>DG16</b>	<b>Single</b>	<b>9600</b>	<b>9600</b>
<b>Ashtech (Thales Navigation)</b>	<b>G12</b>	<b>Single</b>	<b>9600</b>	<b>9600</b>
<b>Ashtech (Thales Navigation)</b>	<b>GG24</b>	<b>Single</b>	<b>9600</b>	<b>9600</b>
<b>Trimble</b>	<b>BD112</b>	<b>Single</b>	<b>9600</b>	<b>9600</b>
<b>Trimble</b>	<b>DSM</b>	<b>Single</b>	<b>9600</b>	<b>9600</b>
<b>Trimble</b>	<b>DSM212</b>	<b>Single</b>	<b>9600</b>	<b>9600</b>
<b>Trimble</b>	<b>SK8</b>	<b>Single</b>	<b>9600</b>	<b>9600</b>
<b>Trimble</b>	<b>4000DS</b>	<b>Single</b>	<b>9600</b>	<b>9600</b>
<b>Trimble</b>	<b>BD750</b>	<b>Dual</b>	<b>38400</b>	<b>57600</b>
<b>Trimble</b>	<b>MS750</b>	<b>Dual</b>	<b>38400</b>	<b>57600</b>
<b>Trimble</b>	<b>5700</b>	<b>Dual</b>	<b>38400</b>	<b>57600</b>
<b>Trimble</b>	<b>4000 SSE</b>	<b>Dual</b>	<b>38400</b>	<b>57600</b>
<b>Trimble</b>	<b>4000 SSi</b>	<b>Dual</b>	<b>38400</b>	<b>57600</b>
<b>NovAtel</b>	<b>OEM4</b>	<b>Dual</b>	<b>57600</b>	<b>57600</b>
<b>NovAtel</b>	<b>Millenium</b>	<b>Dual</b>	<b>38400</b>	<b>57600</b>
<b>Topcon</b>	<b>Topcon</b>	<b>Dual</b>	<b>57600</b>	<b>57600</b>

Assuming data is not being input or output over network sockets, the PC needs a minimum of 2 COM ports. One **COM port** is used for two-way communications to the GPS receiver and the second COM port for the input of **RTCM** corrections. As the second port is for input only it can also be used to output position messages by using a special breakout cable.

If there is more than one RTCM delivery system, or data is to be output on several ports, then additional COM ports will normally be required. These can be any proprietary asynchronous serial board (or PCMCIA card). The Windows drivers for these allow the board's (or card's) ports to be mapped as additional COM ports.

### 3.2.4. GPS Receiver Configurations

#### 3.2.4.1. Ashtech (Thales Navigation) Receivers

Ashtech receivers can be controlled either from within MultiFix or externally using the Evaluate software from Thales Navigation.

Evaluate must be used to establish and configure baud rates, but once communications have been established between the PC and MultiFix then MultiFix can complete the configuration process.

##### 3.2.4.1.1. Configuration from within MultiFix



Assuming communications have been established between MultiFix and the **GPS** receiver then the receiver can be configured automatically by MultiFix.

The Command "Action" \ "Configure Ashtech" will launch the receiver configuration dialogue.

Select [**Set Default Config**] to complete the receiver configuration.

**Note that if using a Z Family receiver then the Baud Rate must be set to a minimum of 38400 due to the large amount of data output from the receiver.**

See [Configure Ashtech](#) for more details.

### 3.2.4.1.2. Ashtech Evaluate Configuration

Direct configuration of Ashtech receivers is usually via the Ashtech Evaluate program; alternatively they can be configured using a terminal program. The following relates to Ashtech Evaluate which is included on the MultiFix installation CD.

Sample configuration files are also available on this CD.



After installing the Evaluate software start the program by clicking the Ashtech Evaluate icon in the start menu. The user will be asked to choose a start up option. Select "Connect to **GPS** Receiver" and click [**OK**].

In the Connection Parameters dialogue select the PC Port, tick the "Initialize from file:" box, remove the tick from all other boxes and select and the preferred initialisation file.

Pre-configured initialisation files can be found on the MultiFix installation CD. These files must first be copied to the Evaluate \ Receiver folder.



Alternatively a file can be created from the text below. Re-name the new text file with a \*.gps extension and place it in the Evaluate \ Receiver folder.

The benefit of using an initialisation file is that all configuration commands are sent to the receiver in a preferred sequence and can be followed by a command that saves all these settings in the battery backed-up memory of the receiver.

On clicking [**Connect**], the software will try to establish connection with the receiver.

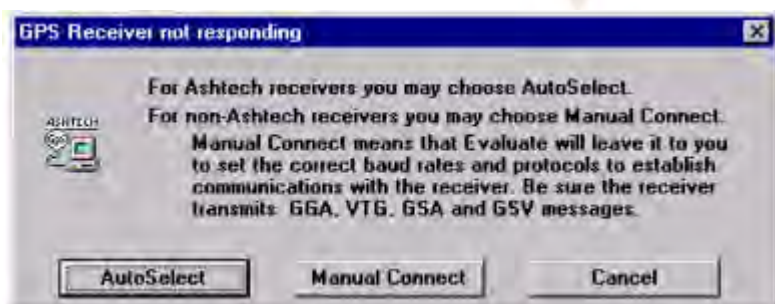

If the PC **COM port** settings do not match the port setting of the internal port on the GPS receiver, Evaluate will report that the GPS receiver is not responding.

By selecting the [AutoSelect], Evaluate will cycle through all possible COM port parameter settings and will report if it finds the current receiver. Evaluate will then connect with the newly found settings.

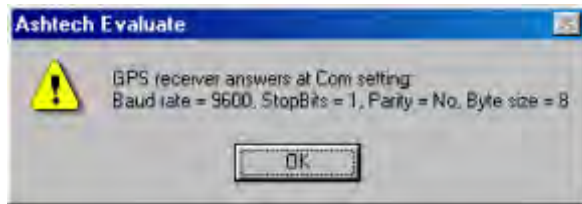

If no matching port settings are found, investigate all cable connections and make sure that the receiver is powered on.

#### 3.2.4.1.3. Ashtech Z-Family

The MF4\_ZX.gps file contains

```
; Initialisation file for ZX-Sensor with MultiFix  
;  
; Set Measurement recording interval  
$PASHS,RCI,1  
; Set Raw Measurement elevation mask to 0 degrees  
$PASHS,ELM,0  
; Set the minimum number of SV measurements to 1  
$PASHS,MSV,1  
; Enable GGA position output  
$PASHS,NME,GGA,A,ON  
; Set GGA output to 10 second intervals  
$PASHS,NME,PER,10  
; Set Multipath Correlator  
$PASHS,MLP,COD  
; Enable UTS  
$PASHS,UTS,Y
```



*; Set the port A baud rate to 38400*

*\$PASHS,SPD,7*

*; Enable the GPS **Almanac** GPS **Ephemeris** and GPS Measurement Messages*

*\$PASHS,OUT,A,MBN,SNV,SAL,BIN*

*; Enable the GPS Almanac*

*\$PASHR,ALM,A*

*; Save all current settings into the battery backed up memory*

*\$PASHS,SAV,Y*

#### 3.2.4.1.4.Ashtech DG16

The MF4\_DG16.**gps** file contains

*; Initialisation file for DG16 with MultiFix*

*;*

*; Set Measurement recording interval*

*\$PASHS,RCI,1*

*; Set Raw Measurement elevation mask to 0 degrees*

*\$PASHS,ELM,0*

*; Set the minimum number of SV measurements to 1*

*\$PASHS,MSV,1*

*; Set Code Measurement Smoothing ('Period','Order')*

*\$PASHS,SMI,300,2*

*; Set Code Correlator Mode (E or S)*

*\$PASHS,CRR,S*

*; Enable UTS*

*\$PASHS,UTS,ON*

*; Enable GGA position output*

*\$PASHS,NME,GGA,A,ON*

---

```
; Set GGA output to 10 second intervals
$PASHS,NME,PER,10

; Set the port A baud rate to 9600
$PASHS,SPD,5

; Enable the GPS Almanac Messages
$PASHS,RAW,SAL,A,ON

; Enable the GPS Ephemeris Messages
$PASHS,RAW,SNV,A,ON

; Enable the GPS Measurement Data
$PASHS,RAW,MCA,A,ON

; Enable the GPS Measurement Data
$PASHS,RAW,PBN,A,ON

; Save all current settings into the battery backed up memory
$PASHS,SAV,Y
```

#### 3.2.4.1.5.Ashtech G12

The MF4\_G12.**gps** configuration file contains the following.

```
; Initialisation file for G12 with MultiFix
;

; Set the SNR Calculation to dB/Hz independent of the hardware
$PASHS,SNR,DBH

; Set Measurement recording interval
$PASHS,RCI,1

; Set Raw Measurement elevation mask to 0 degrees
$PASHS,ELM,0

; Set the minimum number of SV measurements to 1
$PASHS,MSV,1
```

*; Enable GGA position output*  
\$PASHS,NME,GGA,A,ON

*; Set GGA output to 10 second intervals*  
\$PASHS,NME,PER,10

*; Set the port A baud rate to 9600*  
\$PASHS,SPD,5

*; Enable the GPS **Almanac** Messages*  
\$PASHS,RAW,SAL,A,ON

*; Enable the GPS **Ephemeris** Messages*  
\$PASHS,RAW,SNV,A,ON

*; Enable the GPS Measurement Data*  
\$PASHS,RAW,MCA,A,ON

*; Save all current settings into the battery backed up memory*  
\$PASHS,SAV,Y

#### 3.2.4.1.6.Ashtech GG24

The MF4\_GG24.**gps** file contains

*; Initialisation file for GG24 with MultiFix*  
;  
*; Set System to GPS only mode*  
\$PASHS,SYS,GPS

*; Set Measurement recording interval*  
\$PASHS,RCI,1

*; Set Raw Measurement elevation mask to 0 degrees*  
\$PASHS,ELM,0

*; Set the minimum number of SV measurements to 1*  
\$PASHS,MSV,1

*; Enable GGA position output*

*\$PASHS,NME,GGA,A,ON*

*; Set GGA output to 10 second intervals*

*\$PASHS,NME,PER,10*

*; Set the port A baud rate to 9600*

*\$PASHS,SPD,5*

*; Enable the GPS **Almanac** Messages*

*\$PASHS,RAW,SAL,A,ON*

*; Enable the GPS **Ephemeris** Messages*

*\$PASHS,RAW,SNV,A,ON*

*; Enable the GPS Measurement Data*

*\$PASHS,RAW,MCA,A,ON*

*; Save all current settings into the battery backed up memory*

*\$PASHS,SAV,Y*

### 3.2.4.2. Trimble Receiver Configuration

#### 3.2.4.2.1. Trimble BD112

Both the BD112 and the DSM are Trimble single frequency receiver boards. They can be mounted in a 90938. If the 90938 decoder has a BD112 board fitted it will have the suffix F112. If a DSM board is fitted it will have the suffix /M.

The receiver boards do not retain configuration settings when not housed in a 90938, therefore when power is recycled they revert to their default settings. One of those defaults is the **COM port** parameter values which are 9600 8-ODD-1.

Within MultiFix use the Edit **GPS** Receiver dialogue (accessed using “Config” \ “GPS Rx...”) to select BD112 (Trimble) from the drop down list of GPS receivers. Use “Action” \ “Configure TSIP” \ “Default” to configure the receiver to output the required message types.

Note- The “Configure TSIP” menu item only becomes available if a **TSIP** protocol receiver is selected.

If it is clear that MultiFix is not communicating with the receiver it may be due to [baud rate or other incompatibilities](#). In that case use the Trimble TSIP Talker application that can be found on the MultiFix installation CD.

TSIP Talker contains an option called TSIP Break. If on start-up TSIP Talker fails to establish communications with the receiver TSIP Break can be used. That will reset the Trimble serial port to 9600 8-ODD-1. Once communication has been established with those settings TSIP Talker can make further changes to the communication parameter settings.

Once the communication has been established return to “Action” \ “Configure TSIP” \ “Default” in MultiFix to complete the receiver configuration.

#### **3.2.4.2.2. Trimble DSM**

As [Trimble BD112](#) but selecting DSM (Trimble) in place of BD112 (Trimble) from the drop down list of receivers.

#### **3.2.4.2.3. Trimble DSM212**

The DSM212 is a DSM single frequency receiver board housed in its own box.

The front panel of the box has no control buttons.

Connect the MultiFix computer to either of the serial ports on the back of the DSM212 unit.

#### **3.2.4.2.4. Trimble DSM232**

The DSM232 is a DSM dual frequency receiver board housed in its own box.

The front panel of the box has control buttons similar to the MS750.

Connect the MultiFix computer to either of the serial ports on the back of the DSM232 unit.

#### **3.2.4.2.5. Trimble SK8**

The Trimble SK8 is a navigation grade **GPS** receiver. It should not normally be used for survey operations.

The SK8 uses the same **TSIP** protocol as the DSM and BD112. It is also [configured in the same way](#).

#### **3.2.4.2.6. Trimble MS750**

The configuration of the MS 750 dual frequency receiver must be done in two stages. The first stage is via the front panel of the unit itself, and the second stage is via the “Yellow Box” display accessed from the “Receiver” option in the “View” / “GPS” pull-down menus.

**IMPORTANT NOTE – It is essential that the baud rate is set to 38400 as if too low a baud rate (9600) is used then the serial port may be over loaded when there is a high number of SVs visible (greater than 10).**

### 3.2.4.2.6.1. Front Panel Configuration

When the MS 750 is powered up, the front panel displays the Home screen (shown below). Use the green “>” button to toggle to the “Config GPS” display.

```
SV:07 PDOP3.2
RTK(FIX)
```

The screen shown opposite will now appear. Press the “v” button to access the “System Masks” display.

```
Config GPS
Press v to Enter
```

Press the “>” button to enable the cursor. Set the elevation mask to 0° and the **PDOP** mask to 99. Use the “>” button to move the cursor and the “Ú” and “Ú” buttons to change the values. Press the “←↓” button to accept the entry.

```
Cnf: System Masks
Elev 10 Pdop 07
```

Toggle to the “Exit Config” display by pressing the “Ú” button. Press “←↓” to exit this display and return to the “Config GPS” screen. Press “>” to toggle to the “Config Ports” screen.

```
CFG: Exit
Pre to
```

This will bring up the screen shown here. Press the “Ú” button to toggle to the Port A configuration display.

```
Config Ports
Press v to Enter
```

The screen shown opposite will now appear. Use the “>” button to enable the cursor. Set the Baud rates to 38400, 8-None-1 using the “>” button to move the cursor and the “Ú” and “Ú” buttons to change the values. Then press “↵”.

```
CFG: Port A NONE
38400 8-NONE-1
```

**GPS data will only be output to MultiFix from Port A, so it is not necessary to configure ports B-1 and B-2. Toggle past these screens using the “Ú” button.**

```
CFG: NMEA GGA
Port A OFF
```

Ensure that the **NMEA**, GSOFF and Time Tag configuration screens are all “OFF”. Use the “>” button to enable and move the cursor and the “Ú” and “Ú” buttons to change the values. Then press “↵”.

```
CFG: GSOFF Port A
Pos Time OFF
```

```
CFG: 1PPS TimeTag
      Off
```

Toggle to the “Exit Config” display by pressing the “U” button.

Press “↵” to exit this display.

```
CFG: Exit Config
      Press ↵ to Exit
```

This completes the front panel configuration for the MS 750.

#### 3.2.4.2.6.2. MultiFix “Yellow Box” Remote Configuration

MultiFix must be installed on the PC before this stage of the configuration process can be completed. This should be done in accordance with the [instructions](#) outlined in the Software Installation section. Assuming that this has been done and that the receiver unit is connected to the PC, use “View” \ “GPS” \ “Receiver”.

The screen shown below will appear. As soon as communication is established it will change to show the current front panel.

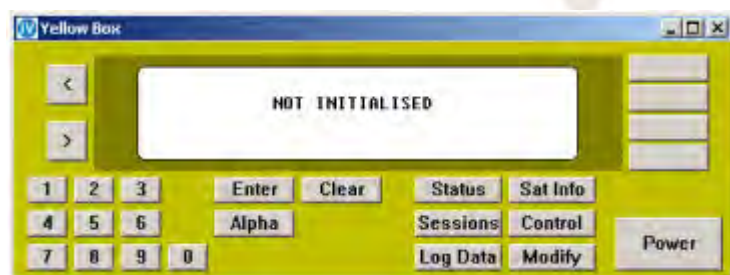

**Press “Alpha” and then “Control” to reach the MENU (CONTROL) screen**

Use the “Alpha” button to toggle to the menu screen displayed opposite. Select the <SERIAL PORT OUTPUT> option by clicking the blank button adjacent to it.





The screen shown below will now appear. Click on the blank button adjacent to the <RT17/BINARY OUTPUT> option to access the next screen.

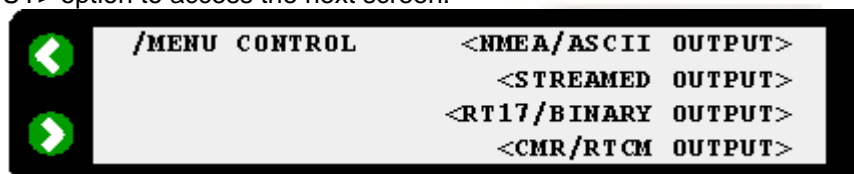

Using the “Enter” button to toggle to the desired parameter. Ensure that the correct output port is enabled and then set MEASUREMENTS and POSITIONS to 1HZ using the “Alpha” button. *EPHEMERIS* should be set to “ON” (optional) and all other parameters should be set to “OFF”.

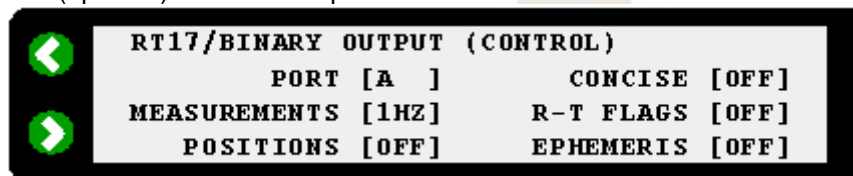

Click on “Enter” until the MENU (CONTROL) screen is displayed.

#### 3.2.4.2.7. Trimble BD750

The Trimble **BD750** is the board version of the MS750 and can be found mounted inside the 90938 Genesis units. I/O configuration of the ports is via the front panel of the 90938. Configuration of the BD750 is via [yellow box](#).

#### 3.2.4.2.8. Trimble 5700

The configuration of the 5700 dual frequency receiver must be done in two stages. The first stage is completed using the Trimble Configuration Toolbox software, and the second stage is via the “Yellow Box” display accessed from the “Receiver” option in the “View” / “GPS” pull-down menus.

IMPORTANT NOTE – It is essential that the baud rate is set to 38400 as if too low a baud rate (9600) is used then the serial port may be over loaded when there is a high number of SVs visible (>10).

### Trimble's Configuration Toolbox

Trimble's 'Configuration Toolbox' software is used initially to establish communications with the 5700. The software is available from Trimble or from a MultiFix installation disk. Connect the receiver to the PC as directed above and start the 'Configuration Toolbox' software.

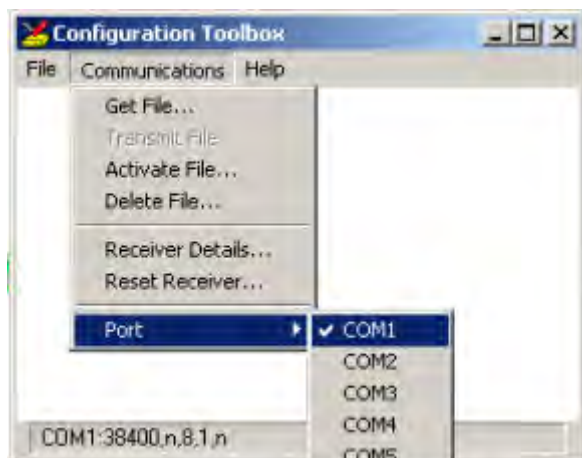

First direct the software to the Com port that the receivers is connected to, "Communications" \ "Port".

Select the receiver type, "File" / "New" select <5700>. This will launch a configuration box.

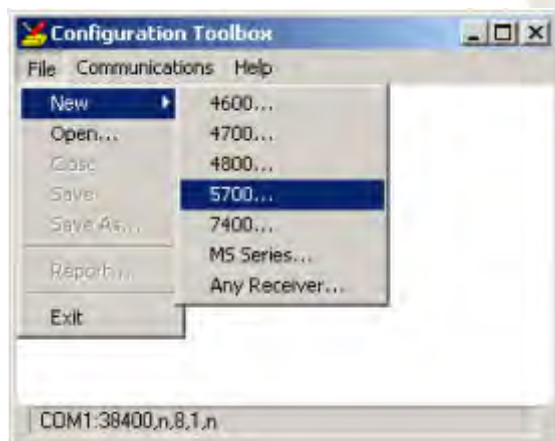

From the "Available" box highlight "Serial" and click **[Add]**.

Select the receiver serial port and set the baud rate to "38400".

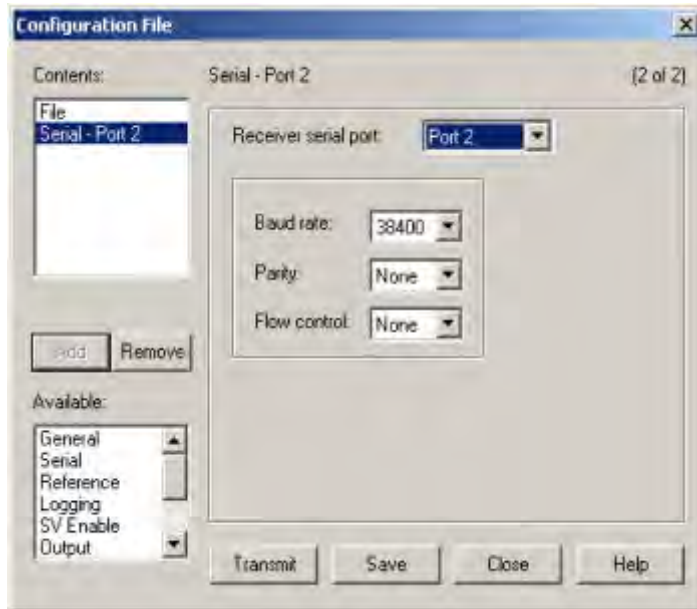

Next select “Output” from the “Available” box and click **[Add]**.  
Under “Message Type” select “All Ports Off”.



Click on **[Transmit]**. This will now send the updates to the receiver.  
If the transfer is successful the following dialogue box will appear. Click **[OK]**.

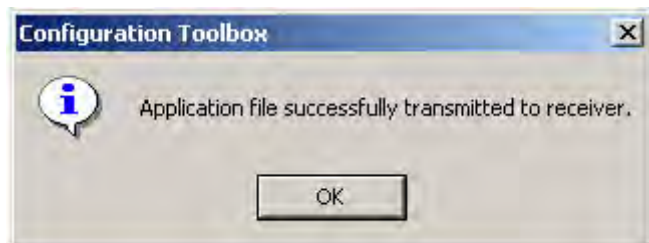

The “Configuration File” dialogue can be closed without saving. Exit the Configuration Toolbox software, the remaining set-up of the 5700 will be completed in MultiFix.

### MultiFix “Yellow Box” Remote Configuration

This part of the configuration is identical to the Trimble MS750, see [MultiFix "Yellow Box" Remote Configuration](#) to complete 5700 configuration.

#### 3.2.4.2.9. Trimble 4000DS

##### Set the *COM Port* Protocol Parameter Values

CONTROL / MORE... /

BAUD RATE/FORMAT /

SERIAL PORT n SETTINGS / CHANGE

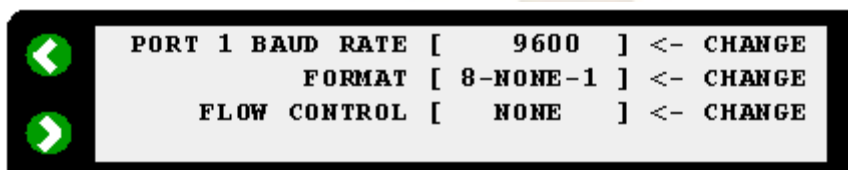

##### Enable MultiFix Control of Trimble Receiver

CONTROL / MORE... /

REMOTE PROTOCOL

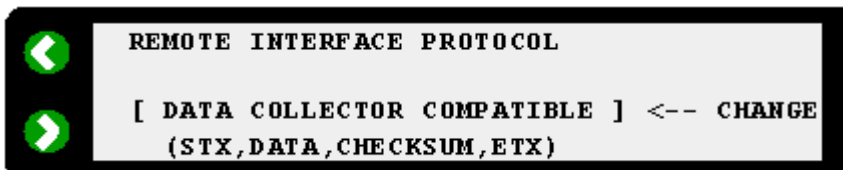

##### Select the Port for the MultiFix/Trimble Receiver Communication

CONTROL / MORE... /

## CYCLE PRINTOUTS /

Ensure there are no other Receiver Cycle Outputs enabled (Use Top  $\beta$ Next)

```

<
OUTPUT EVERY RECEIVER CYCLE
RT SURVEY DATA <-- NEXT
PORT SELECTION <-- NEXT
ENABLE [ PORT 2 ] <-- CHANGE
>

```

### Select the Format for the MultiFix/Trimble Receiver Communication

CONTROL / MORE... /

## CYCLE PRINTOUTS /

(Use Middle  $\beta$ Next)

```

<
OUTPUT EVERY RECEIVER CYCLE
RT SURVEY DATA <-- NEXT
CONCISE FORMAT <-- NEXT
ENABLE [ ON ] <-- CHANGE
>

```

### Select the Port for the Receiver's Input of *RTCM* Corrections

CONTROL /

## RTCM-104 INPUT

```

<
DIFFERENTIAL STATION <-- MORE
RTCM-104 INPUTS [ ON/AUTO ] <-- CHANGE
PORT SELECT [ PORT 1 ] <-- CHANGE
FORMAT [ VERSION 2 ] <-- CHANGE
>

```

### Check there are No Other Outputs Enabled On the MultiFix/Trimble Receiver Communication Port

CONTROL / MORE... /

## NMEA 183 OUTPUT

```

<
NMEA-183 ENABLE [ OFF ] <-- CHANGE
OUTPUT CONTROL ALM [ OFF ] <-- CHANGE
BWC [ OFF ] <-- CHANGE
MORE
>

```

### Check that the Elevation Mask is not set higher in the Receiver than in MultiFix (it can be lower)

CONTROL / MORE... /

## MASKS/SYNC TIME

```

< POSITIONING MASKS/SYNC TIME: |
ELEVATION MASK = +10° | MINUS
PDOP MASK = 07.0 |
SV SYNC TIME = 001.0 SEC | ACCEPT
>

```

### 3.2.4.2.10. Trimble 4000 SSE

When powering up the following screen will appear. In order to reach the standard screen press the "CLEAR" button on the front panel of the receiver.

```

< QUICK-START NOW! (SINGLE SURVEY) --
START PRE-PLANNED SURVEY (SINGLE SURVEY) --
> START FAST STATIC OR KINEMATIC SURVEY --
MORE --

```

The standard screen, shown here, will now appear.

```

< POSITIONING - AUTO SV SELECT | ELEV/AZM
POSITION FIX: LAT/LON/HEIGHT | POSITION
SV029,03,23,31,21,15 | DATE
> PWR1+[#####] 07:58:25 UTC | OPTIONS

```

The following needs to be configured/checked.

#### Set the COM Port Protocol Parameter Values

CONTROL / MORE... /

BAUD RATE/FORMAT /

SERIAL PORT n SETTINGS / CHANGE

```

< PORT 1 BAUD RATE [ 9600 ] <- CHANGE
FORMAT [ 8-NONE-1 ] <- CHANGE
> FLOW CONTROL [ NONE ] <- CHANGE

```

#### Enable MultiFix Control of Trimble Receiver

CONTROL / MORE... /

REMOTE PROTOCOL

```

<
REMOTE INTERFACE PROTOCOL
>
[ DATA COLLECTOR COMPATIBLE ] <-- CHANGE
(STX, DATA, CHECKSUM, ETX)

```

### Select the Port for the MultiFix/Trimble Receiver Communication

CONTROL / MORE... /

CYCLE PRINTOUTS /

Ensure there are no other Receiver Cycle Outputs are enabled (Use Top βNext)

```

<
OUTPUT EVERY RECEIVER CYCLE
RT SURVEY DATA <-- NEXT
PORT SELECTION <-- NEXT
ENABLE [ PORT 2 ] <-- CHANGE
>

```

### Select the Format for the MultiFix/Trimble Receiver Communication

CONTROL / MORE... /

CYCLE PRINTOUTS /

(Use Middle βNext)

```

<
DIFFERENTIAL STATION <-- MORE
RTCM-104 INPUTS [ ON/AUTO ] <-- CHANGE
PORT SELECT [ PORT 1 ] <-- CHANGE
FORMAT [ VERSION 2 ] <-- CHANGE
>

```

### Check that there are no other outputs enabled On the MultiFix/Trimble Receiver Communication Port

CONTROL / MORE... /

NMEA 183 OUTPUT

```

<
NMEA-183 ENABLE [ OFF ] <-- CHANGE
OUTPUT CONTROL ALM [ OFF ] <-- CHANGE
BWC [ OFF ] <-- CHANGE
MORE
>

```

### Check that the Elevation Mask is not set higher in the Receiver than in MultiFix (it can be lower)

CONTROL / MORE... /

## MASKS/SYNC TIME

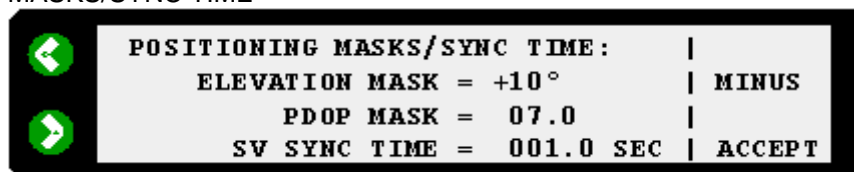

Ensure the receiver is set to dual frequency mode

CONTROL / MORE.../

L1 / L2 OPERATION

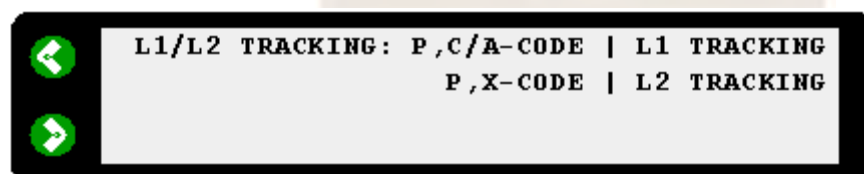

Only the L2 code can be disabled. Ensure that both the L1 and L2 codes are enabled.

### 3.2.4.2.11. Trimble 4000 SSi

When powering up the following screen will appear. In order to reach the standard screen press the "CLEAR" button on the front panel of the receiver.

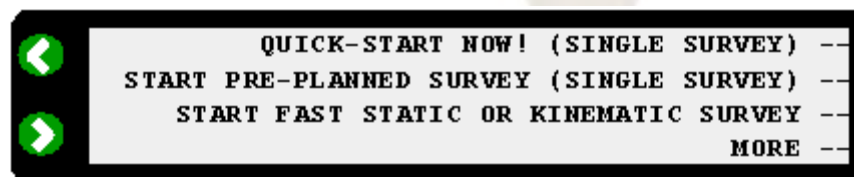

The standard screen, shown here, will now appear.

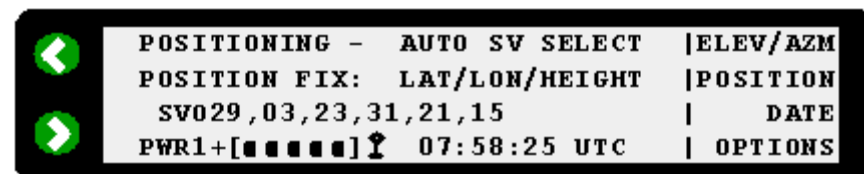

The following needs to be configured/checked.

Set the **COM Port Protocol Parameter Values**



CONTROL / MORE.../  
BAUD RATE/FORMAT /  
SERIAL PORT n SETTINGS / CHANGE

```
PORT 1 BAUD RATE [ 9600 ] <- CHANGE
      FORMAT [ 8-NONE-1 ] <- CHANGE
      FLOW CONTROL [ NONE ] <- CHANGE
```

#### Enable MultiFix Control of Trimble Receiver

CONTROL / MORE... /  
REMOTE PROTOCOL

```
REMOTE INTERFACE PROTOCOL
[ DATA COLLECTOR COMPATIBLE ] <-- CHANGE
(STX, DATA, CHECKSUM, ETX)
```

#### Select the Port for the MultiFix/Trimble Receiver Communication

CONTROL / MORE... /  
CYCLE PRINTOUTS /  
Ensure there are no other Receiver Cycle Outputs are enabled (Use Top βNext)

```
OUTPUT EVERY RECEIVER CYCLE
      RT SURVEY DATA <-- NEXT
      PORT SELECTION <-- NEXT
      ENABLE [ PORT 2 ] <-- CHANGE
```

#### Select the Format for the MultiFix/Trimble Receiver Communication

CONTROL / MORE... /  
CYCLE PRINTOUTS /  
(Use Middle βNext)

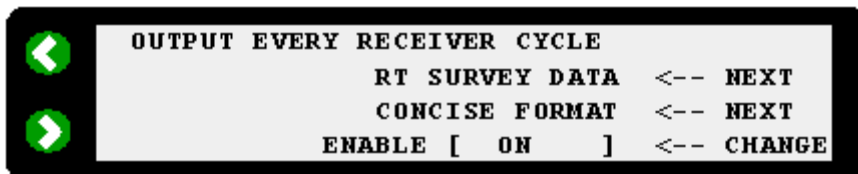

### Select the Port for the Receiver's Input of *RTCM* Corrections

CONTROL/  
RTCM-104 INPUT

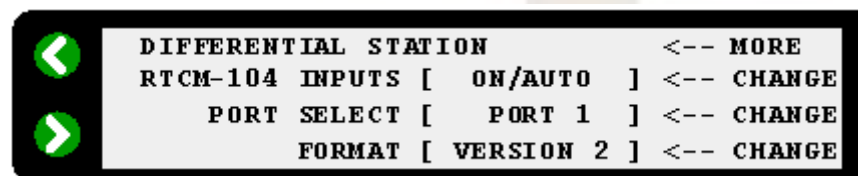

### Check there are no other outputs enabled On the MultiFix/Trimble Receiver Communication Port

CONTROL / MORE... /  
NMEA 183 OUTPUT

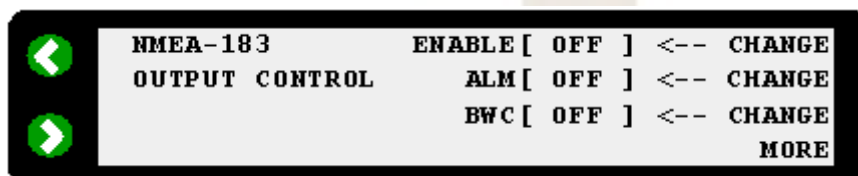

### Check that the Elevation Mask is not set higher in the Receiver than in MultiFix (it can be lower)

CONTROL / MORE... /  
MASKS/SYNC TIME

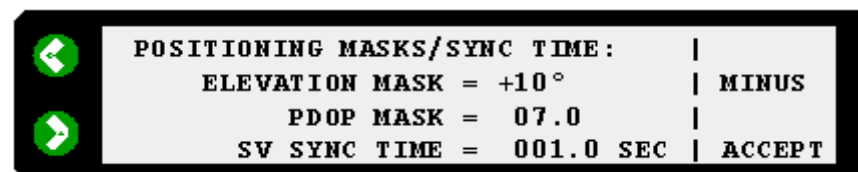

### Ensure the receiver is set to dual frequency mode

CONTROL / MORE... /  
L1 / L2 OPERATION

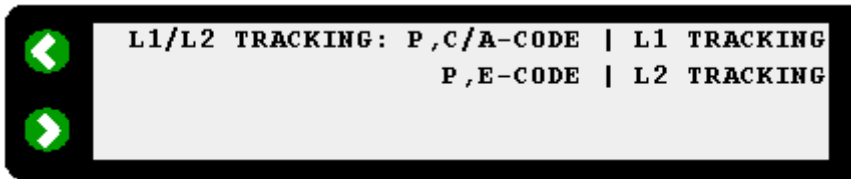

Only the L2 code can be disabled. Ensure that both the L1 and L2 codes are **enabled**.

### 3.2.4.3. NovAtel Receivers

#### 3.2.4.3.1. NovAtel Millennium

The NovAtel Millennium **GPS** is configured using the NovAtel GPSolution software.

The GPSolution software is provided with the NovAtel receiver.

##### 3.2.4.3.1.1. Communicating with the NovAtel Millennium OEM Card

For the NovAtel Millennium once communication has been established with the receiver using the NovAtel GPSolution software, MultiFix can then be used to finalise the configuration.

Communicating with the NovAtel Millennium OEM Card:

Connect COM 1 on the NovAtel Millennium to COM 1 on the PC using a standard NovAtel communication cable.

Run GPSolution.

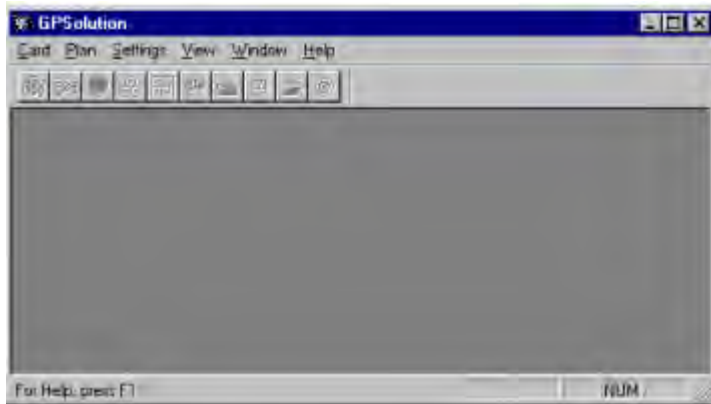

Go to "Card/Open.."

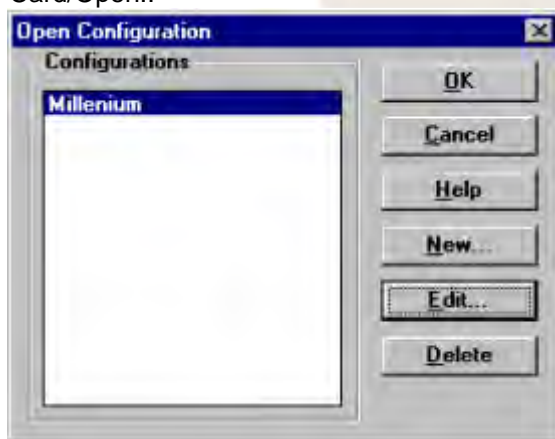

Create a "New..." configuration, for example with the name 'Millennium', or "Edit..." it to alter the settings.

Click "Settings..." on the edit configuration dialogue, to enter the window for configuring the Port parameters.

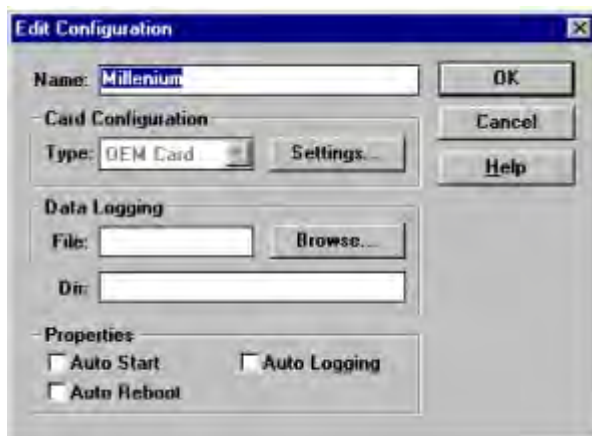

Select:

**PC Port** COM1

**OEM Port** COM1

**Baud Rate** 57600

**Flow Control** None.

Confirm with <OK>. This will bring you back in the 'Open Configuration' window. Select <OK> GPSolution will now attempt to establish communication with the NovAtel Millennium OEM card.

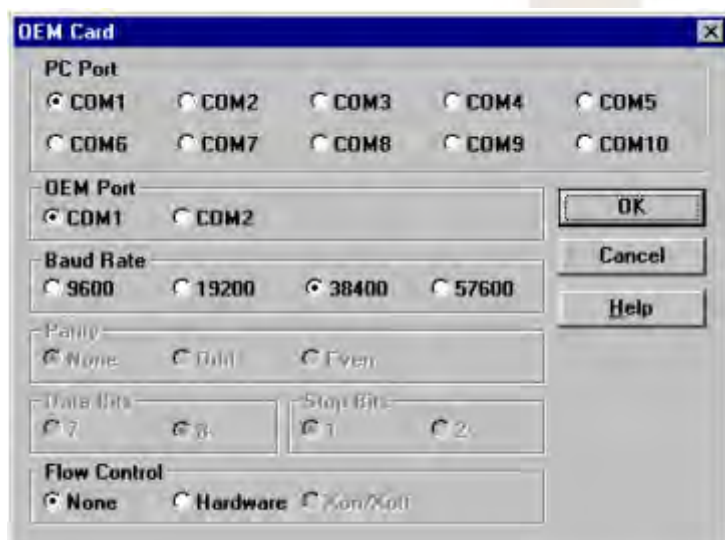

In case this procedure fails to establish a connection at a 57600 baud rate and establishes communication at a lower rate, the following steps allow the user to change the speed of the port. Go to the "View/Command Console". This will open the adjacent window:

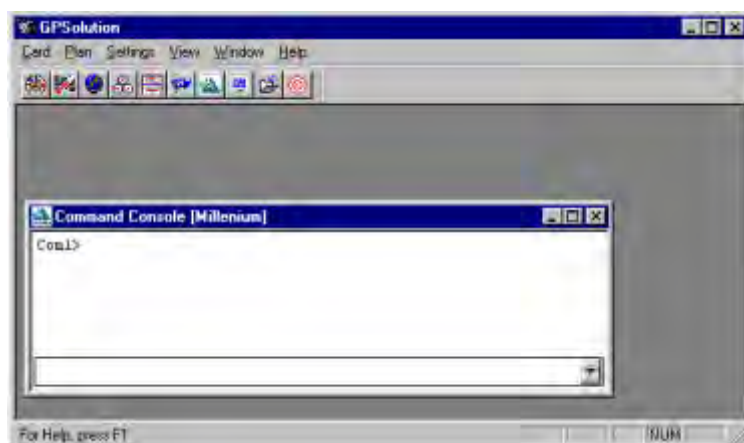

Type `Com1 57600,n,8,1,n,off,on` in the Command Line followed by Enter. The display will read:

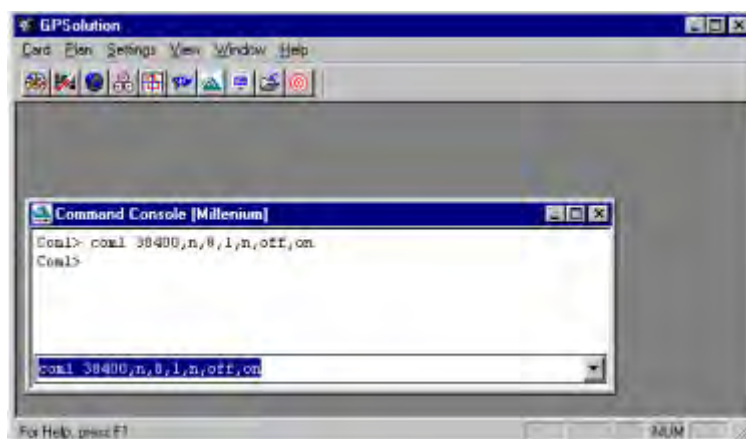

Upon changing the baud rate, you will lose communication with the card. In this case, close the GPSolution application and restart using the configuration file created earlier.

#### 3.2.4.3.1.2. Configuring the NovAtel Millennium from within MultiFix

Assuming communications have been established between MultiFix and the GPS receiver then the receiver can be configured automatically by MultiFix.

The Command "Action" \ "Configure Millennium" will launch the receiver configuration dialogue.



Select [**Set Default Config**] to complete the receiver configuration.

### 3.2.4.3.2. NovAtel OEM4

Configuration is similar to the millennium except NovAtel GPSolution 4 software is required.

#### 3.2.4.3.2.1. Communicating with the NovAtel OEM4 Card

Connect COM1 on the NovAtel OEM4 to COM1 on the PC using a standard NovAtel communication cable.  
Run NovAtel's GPSolution 4 software.

Go to "Device/Open"

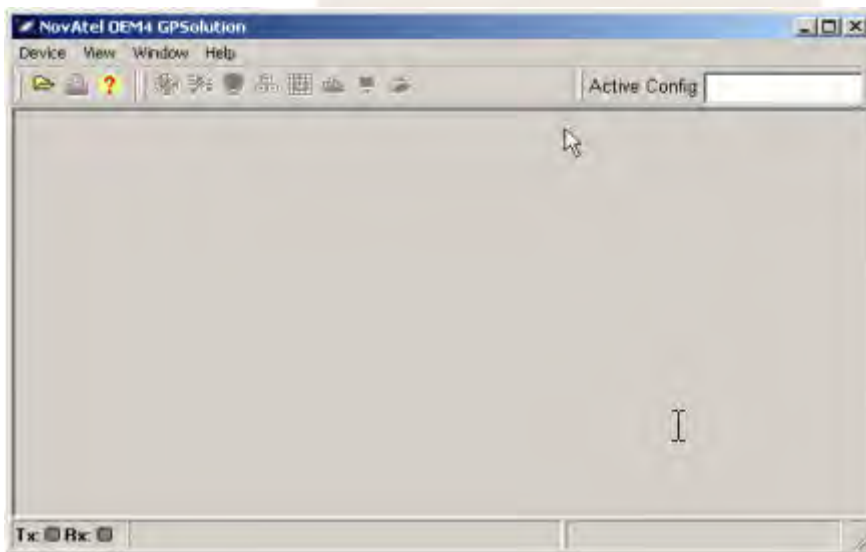

Create a "New..." configuration, for example with the name 'OEM4', or "Edit..." it to alter the settings.



Type in a name and then click “Settings...” on the edit configuration dialogue, to enter the window for configuring the Port parameters.

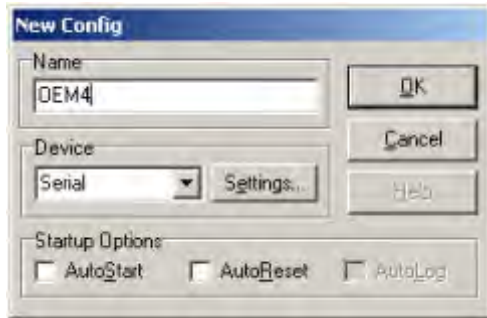

Select:

**PC Port COM1**

**Baud Rate 57600**

**Hardware handshaking unchecked**

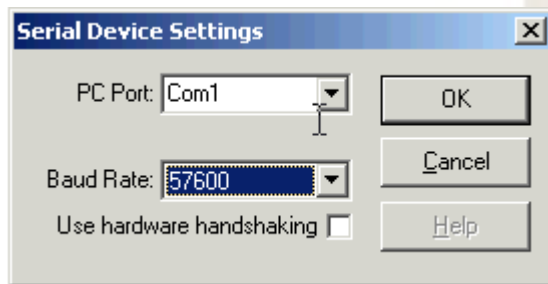

Confirm with <OK> twice. This will bring you back in the ‘Open Configuration’ window. Select <Open> GPSolution will now attempt to establish communication with the NovAtel OEM4 card

In case this procedure fails to establish a connection at a 57600 baud rate and establishes communication at a lower rate, the following steps allow the user to change the speed of the port.

Go to the “View/Console”. This will open the adjacent window:





Type **Com com1,57600,n,8,1,n,off** in the Command Line followed by Enter. The display will read:

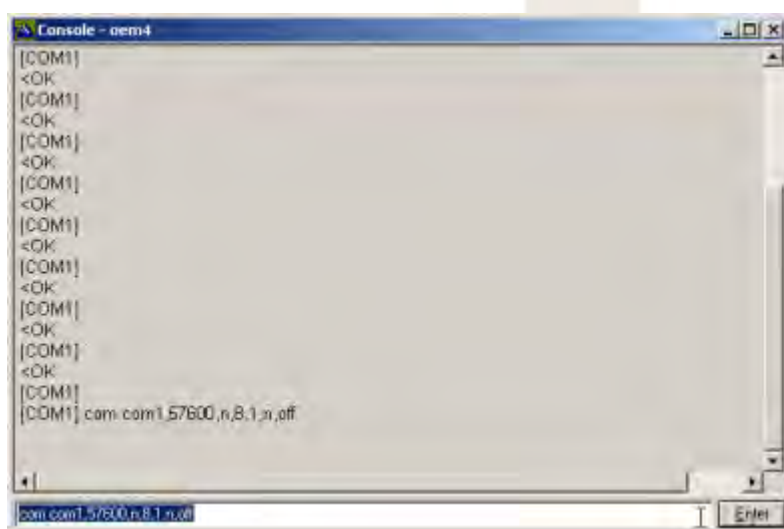

Upon changing the baud rate, you will lose communication with the card. In this case, close the GPSolution application and restart using the configuration file created earlier, but changing the baud rate to 57600 in 'Device Settings'.

#### 3.2.4.3.2.2. Configuring the NovAtel OEM4 from within MultiFix

Assuming communications have been established between MultiFix and the GPS receiver then the receiver can be configured automatically by MultiFix.

The Command "Action" \ "Configure OEM4" will launch the receiver configuration dialogue.



Select [**Set Default Config**] to complete the receiver configuration.

#### 3.2.4.4. Topcon Receivers

Assuming communications have been established between MultiFix and the GPS receiver, then the receiver can be configured automatically by MultiFix.

The Command "Action" \ "Configure Topcon" will launch the receiver configuration dialogue.



Select [**Send Default Config**] to complete the receiver configuration. Alternatively, type in known commands and select [**Send**] to send these to the receiver.

#### 3.2.5. MultiFix Files

Once MultiFix has been installed and the program is run MultiFix creates several files in the folder specified by the operator for saving the configuration file.

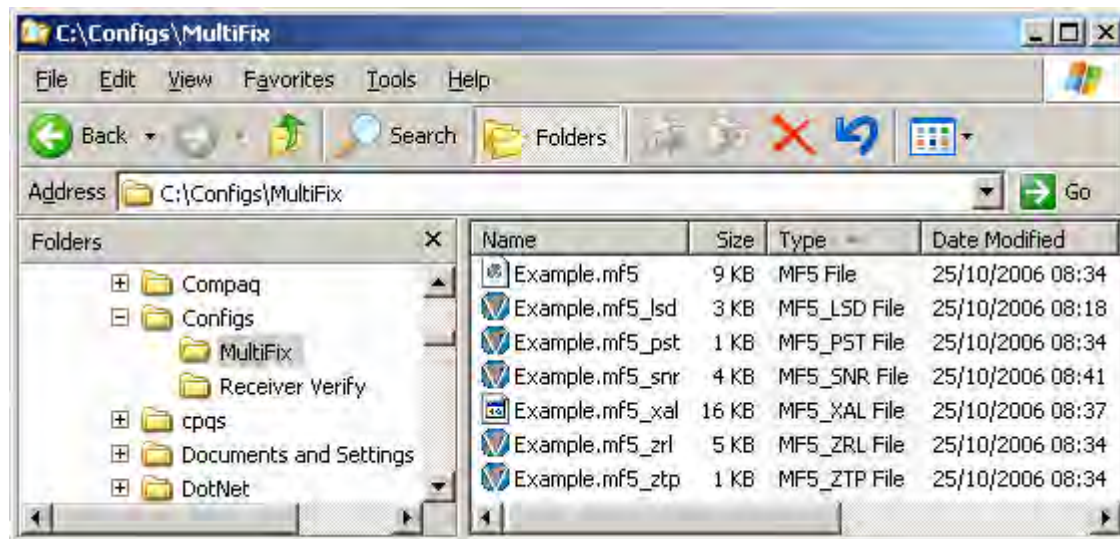

The \*.MF5 is the core MultiFix configuration file and is stored in XML format.

\*.MF5\_PST is the Persistence file; it contains the number, type, position and contents of windows in the application workspace when a configuration file is saved. It is written when the program is exited.

\*.MF5\_SNR is the receiver signal to noise ratio weighting tables. This is written periodically during a program run and when the configuration file is saved.

\*.MF5\_XAL file is the **GPS almanac**. This will be updated as the almanac changes and when the configuration file is saved. The XAL file is stored as in an XML format and can be exported to other applications.

\*.MF5\_ZRL is the Reference Location file that contains the positions of the reference stations in use. It will be written when a new Type 3 position for a reference station is received and when the configuration file is saved.

\*.MF5\_ZTP is the Trial Point configuration file that contains the current trial point position. It is updated when the position as derived by the first calculation has moved more than 1 km from the existing trial point position and when the configuration file is saved.

MF5\_LSD is the Logging Schedule and will only be created when the program has logged data. It contains information on what has been logged and the identifying numbers given to the data. It is only written once logging has been started.

If log files are to be returned for analysis then ALL the above files should be returned also.

It is possible to modify an **NMEA** output string to accommodate clients' software. The definition of this modified string can be saved to a \*.rdf file. The \*.rdf file can then be reloaded. By default the file is saved to the MultiFix configuration file directory.

This folder will also contain text files logging any Type 16 messages that are received during that day. See [Type 16](#).

### 3.2.6. To Run MultiFix

MultiFix can be opened a variety of ways.

Use Windows Explorer to display the contents of the folder containing the MultiFix program files and then double-clicking the "Multi5" application icon.

Use "Start" \ "Programs" \ "MultiFix5" and click "MultiFix5".

## 3.3. REAL TIME OPERATION

### 3.4. THE TOOL BAR







The Tool bar provides quick access to the most commonly used functions and windows in MultiFix.

A description for each button is given when the mouse is held over the button for brief period.

Details of each button are given below.

	<b>Open Configuration</b>	Open configuration
---	---------------------------	--------------------

	<b>Save Configuration</b>	This is the same as the "File" \ "Save" command.
	<b>Start Logging</b>	This is the same as the "Logging" \ "Zero" \ "Start" commands.
	<b>Start Logging</b>	This is the same as the "Logging" \ "Zero" \ "Pause" command. NB this option is only visible once logging has been started.
	<b>Stop Logging</b>	This is the same as the "Logging" \ "Zero" \ "Stop" command. NB this option is only visible once logging has been started.
	<b>SV Status</b>	This is the same command as "Action" \ "SV Status" and calls up the disable SV window.
	<b>Work Area</b>	This is the same command as "View" \ "Work Area" and opens the work area display
	<b>IO Scroller</b>	This is the same command as "View" \ "IO" \ "Scroller" and opens the IO scroller view.
	<b>GPS SNR</b>	This is the same command as "View" \ "GPS" \ "SNR" and opens the <b>GPS</b> Signal to Noise Ratio display.
	<b>Almanac</b>	This is the same command as "View" \ "GPS" \ "Almanac" and opens the GPS <b>Almanac</b> display.
	<b>Latency</b>	This is the same command as "View" \ "Corrections" \ "Latency" and opens the <b>RTCM</b> Latency window.
	<b>Type 16</b>	This is the same command as "View" \ "Corrections" \ "Type 16" and opens the Recent Type 16 warning window.

	<b>Status</b>	This is the same command as "View" \ "Calc" \ "Status" and opens the standard Calculation Status window.
	<b>Position</b>	This is the same command as "View" \ "Calc" \ "Position" command and opens the Position display window.
	<b>Offset</b>	This is the same command as "View" \ "Calc" \ "Offset" and opens the Position Offsets window.
	<b>Time Series</b>	This is the same command as "View" \ "Calc" \ "Time Series" and opens the Time Series Plot window.

The toolbar can be hidden using the "Options" / "Hide Toolbar" command.

### 3.4.1. File

At the bottom of the "File" menu is a list of recently used configuration files.

Clicking on one of these files opens up the chosen configuration.

#### 3.4.1.1. New

To start a new MultiFix configuration select this option.

Be aware that starting a new configuration file will close the existing configuration and cease real time operation if the program is already in use. MultiFix will request confirmation before closing the existing configuration file and if the configuration has not been saved the user will again be prompted.

#### 3.4.1.2. Open

When initially opened the program does not know which configuration file to use. If a previously prepared configuration exists use this facility to select it.

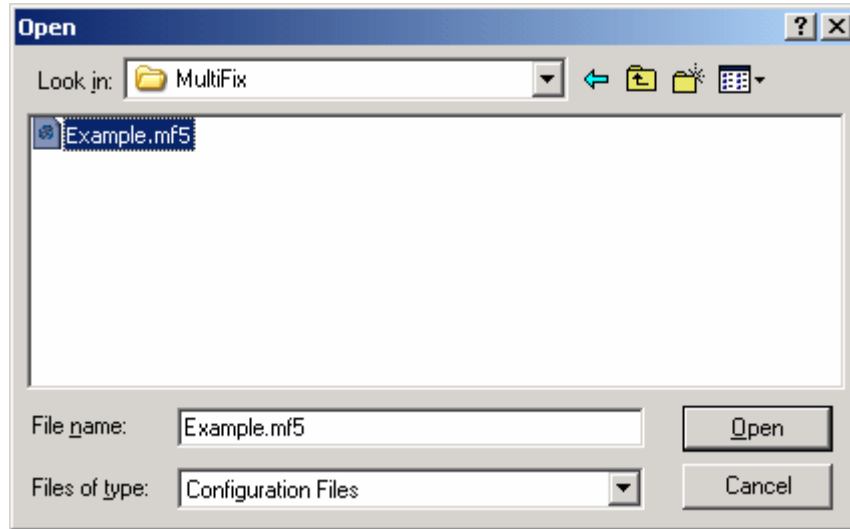

The configuration files contain the program name and version identifiers in a file header. They also include a configuration file version number. The program will not allow configuration files to be opened that are not compatible with the version of MultiFix that is currently being run. However if the configuration file version is the same they can be used even though created by a different program version.

File open can also be accomplished using the  button.

#### 3.4.1.3. Save

The configuration file is not automatically saved when changes are made. This facility is therefore used to update the configuration file with the current settings. If the set-up is being undertaken for the first time and the configuration file does not have an identity, the use of "File" \ "Save" will open the Save As dialogue where a file name must be entered. Once a configuration file has been named, the use of "File" \ "Save" performs a save without calling up the Save As dialogue.

The name of the current configuration file appears in the application workspace title bar. If configuration changes are made that have not been saved, that file name has an "\*" appended to it. After using File \Save the "\*" is removed.

File saving can also be accomplished using the  button.

#### 3.4.1.4. Save As

If the latest configuration is to be saved without overwriting the current configuration file use the “File” \ ”Save As...” option. This gives the option to create a new file leaving the previous file intact. The program immediately uses the new file as the current configuration file.

The Save As dialogue requires the operator to enter a name for the new configuration file. If an existing file name is entered the program will overwrite that file.

#### 3.4.1.5. Exit

This exit route is immediate if no configuration file is loaded.

Confirmation is required if a configuration file is in use. The user will be prompted to save the configuration if they have not already done so.

If the program is exited using the  button when the current configuration has not been saved, a dialogue is presented asking whether to save the configuration prior to exit or whether to cancel the exit. If there have been no configuration changes then the program will terminate immediately.

### 3.4.2. Logging

The Logging menu items shown above will change depending on the current state of logging. If no logging is taking place it will be “Edit” and “Start”, if logging is ongoing it will be “Pause” and “Stop” and if logging is paused it will be “Resume” and “Stop”.

The *Rinex* Logging menu will only be visible if “RINEX” has been enabled under the options menu.

#### 3.4.2.1. Zero

Zero log files can also be logged. These files can be read by LOGPUMP where raw data can be replayed and directed back into MultiFix regenerating pseudo-real time positions. Those positions can then be output from MultiFix to QUAL 2 or POSITIONVIEW software.

It is therefore possible for recoded real-time positions to be compared with regenerated positions.



### 3.4.2.1.1.Edit

Select the type of logging required. Note there are not separate raw and position files, the Zero Log (\*.zer) files can contain both raw measurement and position data.

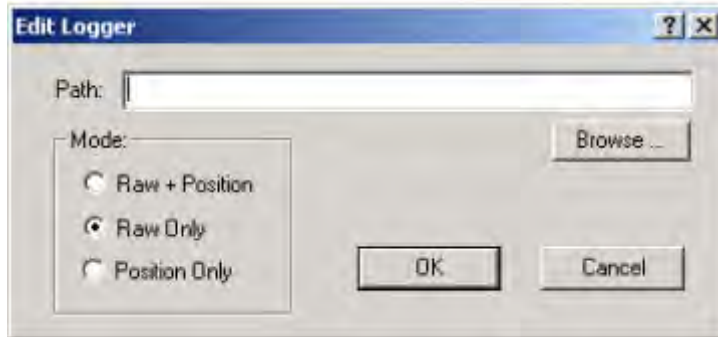

In most cases it is recommended to use the "Raw Only" option.

Select the folder into which the logged data is to go either by typing in the destination or by using the **[Browse...]** facility. This provides the Browse for Folder dialogue. The path can be defined by clicking on the desired destination folder.

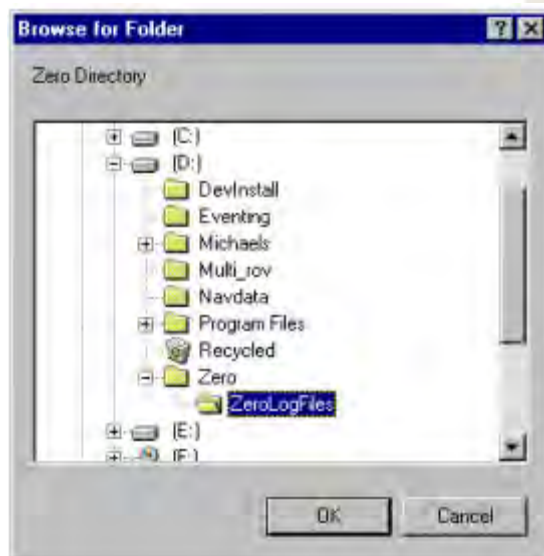

Be aware that typing in a non-existent path **will not create a folder**. If a new folder is required for data logging it must be created on the desired hard drive with Windows Explorer before logging begins. If a viable destination is not entered the \*.zer log files will be written into the MultiFix installation directory.



When the path and mode of logging have been selected click **[OK]**.

The files are named with the Julian day and PC time at the moment of creation, e.g. 061-1114.

When a file reaches 1.4 Mbytes in size it will automatically close and a new one will be created.

#### 3.4.2.1.2.Starting, Stopping and Pausing

The same is accomplished using the toolbar  button.

This will start the logging process. When data is being logged the menu options and toolbar buttons will change to "Pause"  and "Stop". .

"Pause" will arrest the logging process until "Resume" or "Stop" are selected.

"Resume", which has the same button as Start, will restart logging into the existing file.

"Stop" will close the current log file.

When logging is started a Logging Schedule file is created in the same folder as the MultiFix application.

This file is needed so that LOGPUMP can be set up correctly for the output of data. The schedule contains the MultiFix version number, reference station and calculation status information. There is only one file so if logging is stopped and then re-started the existing file is overwritten. This means that if configuration changes have been made between one log session and subsequent log sessions the Logging Schedule file will only be relevant for the last session. Therefore, if changes are to be made after logging is stopped use Explorer to make a copy of the Schedule file and keep a note of the \*.zer log files to which it relates. Do not make configuration changes while logging is on going.

When being archived or when being forwarded for replay analysis, the configuration files (including the schedule file) should be kept with the log files.

#### 3.4.2.2. Rinex

MultiFix has the capability to log raw **GPS** observation in the **RINEX** (Receiver Independent Exchange) format. This is used to collect data for carrier phase post processing; typical usage is for verification after a final fix or for a post-processed **RTK** solution.

MultiFix will automatically generate file names following the standard naming convention, as follows:

**SSSSDDDH.YYT**

Where:

**SSSS** is the four character site identifier, this is user defined

**DDD** is the Julian day of year

**H** is a letter to differentiate between multiple files from the same day

**YY** is the year

**T** is the file type, either o for observation files or n for navigation files.

MultiFix will automatically generate the files and file names based on the information provided. The file differentiator (H) used by MultiFix is a letter and will increase automatically when multiple sessions are conducted on the same day.

MultiFix will generate both observation (\*.xox) and navigation files (\*.xnx).

#### 3.4.2.2.1.Edit

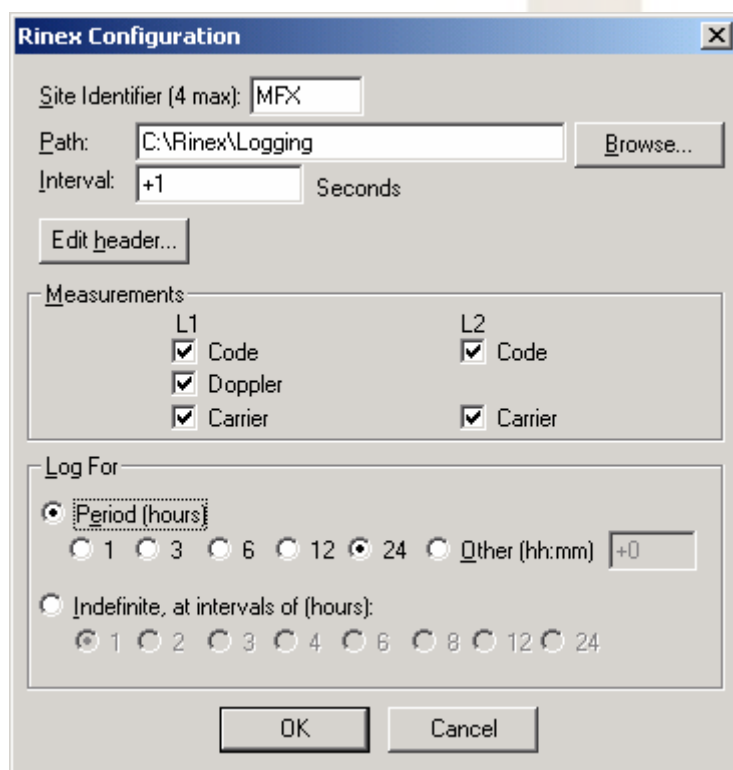

Certain information is essential for the logging process. A unique 4-letter site identifier must be set which is used in the subsequent file name. Care should be taken not to duplicate the site name or to change it once it has been assigned to a specific locale.

Select the folder into which the logged data is to go either by typing in the destination in the "Path:" field or by using the **[Browse]** facility.

The "Interval" box is used to enter the logging interval for data collection. This will trigger a record to be written every integer number of seconds past the hour. Therefore a setting of 30 seconds will write a measurement on every minute and at 30 seconds past every minute.

For Long range carrier phase post processing (such as to IGS stations) 30 seconds should be selected. For **RTK** post processing 1 second should be selected.

The "Measurements" section allows the user to select what measurements are required. In most cases all measurements should be selected.

**NB** a dual frequency receiver and antenna must be used to log **L2** data.

The "Log For" options allow the user to define a predetermined file length based on time.

By selecting "Period" and an associated length of time from the radio buttons MultiFix will only log for the selected period.

Selecting "Indefinite" will force MultiFix to write sequential files of the defined period. This will set the start time of each file to the nearest round period of time. Therefore if a one hour interval is selected each file will start and stop on the hour. This will make the first file short of one hour but subsequent files will be as specified.

Periods of longer than one hour will be rounded into an even number in a 24 hour period e.g. a six hour period will start/stop at 00:00, 06:00; 12:00 and 18:00.

All time periods are set to **GPS** time and not local time.

#### 3.4.2.2.2.Edit Header

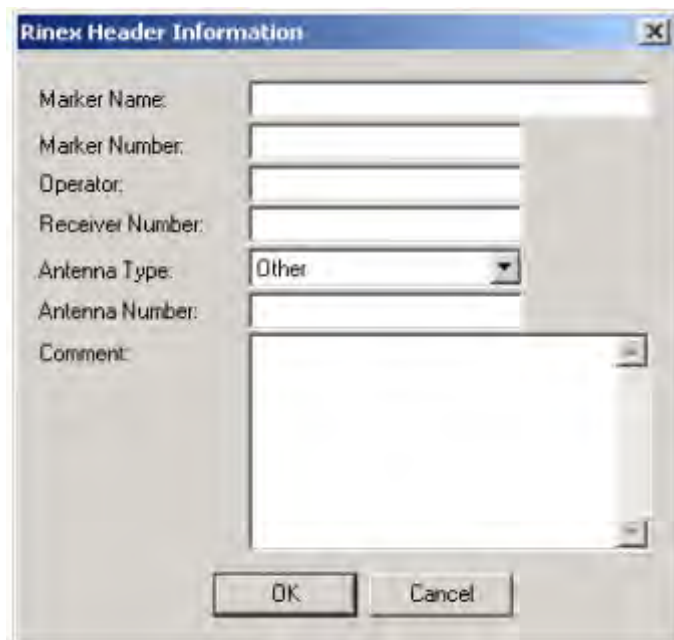

The edit header dialogue allows the user to enter additional information to be written to the header. This data can be used in subsequent processing so should be filled in as completely as possible.

The “Marker Name” and “Marker number” entries are free text, these can be different (or the same) as the 4 letter Marker ID. This allows the user to provide a more legible name to assist in processing.

The “operator” is the name of the individual who collected the data.

The “Receiver Number” is the serial number of the **GPS** Receiver used to collect the data and is used for record keeping. **Note that the receiver type is entered into the file automatically based on the GPS Receiver type selected within the “Config” \ “GPS Rx...” menu in MultiFix.**

The “Antenna Type” is restricted to a drop down list of antennas commonly used with MultiFix. If the currently used antenna is not in the list then “Other” should be selected.

“Antenna Number” is a free text entry box for the serial number of the antenna, again used for record keeping.

The final “Comment” Box allows the user to enter any other pertinent information that may be of use to the processor.

### 3.4.2.2.3.Starting, Stopping and Pausing

This will start the logging process. When data is being logged the menu options will change to “Pause” and “Stop”.

“Pause” will suspend the logging process until “Resume” or “Stop” are selected.

“Resume” will restart logging into the existing file.

“Stop” will close the current log file.

## 3.4.3. Configure

### Note:

The “P2/94 Output” will only be visible if “P2/94” has been enabled in the “Options” menu.

### 3.4.3.1. IO

#### 3.4.3.1.1.Comm

Earlier it was explained that the “Programs” / “MultiFix5” / “IO Config” application needed to be run after installation to define what [ports the computer](#) has available. The parameters selected there determine the dialogue box that is presented when “Config” / “IO” / “Comm...” is selected.

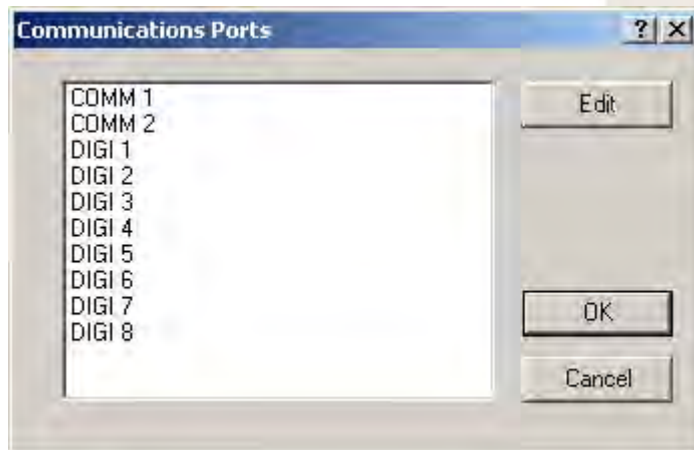

Highlight one of the ports to be used and click **[Edit]**. This opens another dialogue box for setting the port parameter settings.

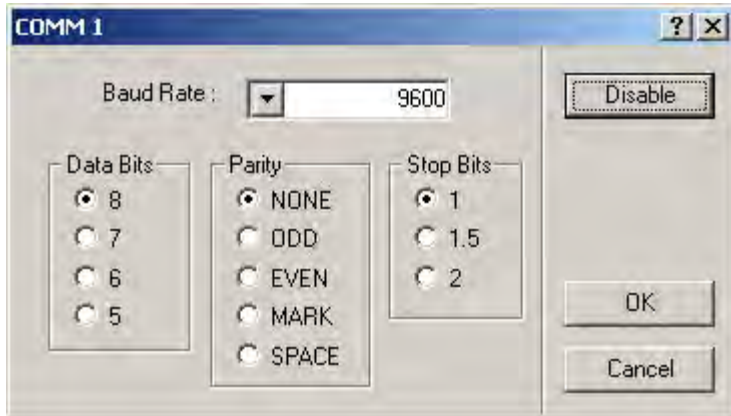

Click the **[Enable]** button to activate the port and set the **Baud Rate**, **Data Bits**, **Parity** and **Stop Bits**.

#### 3.4.3.1.2.Sockets

To be able to distribute and receive data over a network via sockets assumes each computer has Transmission Control Protocol / Internet Protocol (**TCP/IP**) installed. Sockets have the advantage over COM ports in that two or more programs can access the same data.

Sockets can transfer data between programs running on different computers or between two or more programs running on the same computer. (If a standalone (non-networked) computer running Windows NT is used and the data is to be shared between multiple programs running on that PC then the MS Loopback Adapter network adapter must be installed).

The TCP/IP protocol is a family of protocols that allow Internet data communication. Included in that family are two transport layer protocols, the Transport Control Protocol (TCP) and the User Datagram Protocol (**UDP**)

- The Transport Control Protocol establishes sessions between a Server and however many Clients that are accessing that Server. There is continual presence checking and acknowledging between each Server/Client pairs with messages always received in the order they were issued. A Server does not have control of the number of Clients that access the socket on which data is being presented. (It is often perceived that the Server provides data and the Client receives data, but once the connection is established the link is two-way).
- The User Datagram Protocol does not have the end-to-end checking overhead of the TCP. Instead packets of data are simply issued to the Internet in either broadcast mode, where any networked

computer on the **LAN** can receive them, or in addressed mode where the data packets have headers specifying the addressees for whom the packets are intended. There is no guarantee with this protocol that the messages will arrive in the order they were issued. When setting up “Ribbons” to output datagrams a time interval can be specified to prevent data becoming corrupted. Broadcast datagrams cannot pass routers linking Local Area Networks (LAN) unless specifically configured.

For most situations where Local Area Networks are involved Server / Client TCP sockets are the best choice Internet transport protocols.

#### 3.4.3.1.2.1. The MultiFix Computer as a TCP Client

For a Client to make contact with a Server, the operator must know the IP address (or the network identification name - see below) of the Server computer and the port number the Server is outputting the required data.



First, in the “PC Names” table click **[New]**.



There are two possible ways of defining the server PC.



If the numerical IP address is known, enter a PC name in “Name:” and the IP address in “Address:” and click **[Resolve>>]**. Click **[OK]**.



If the IP address is not known but the computer’s network identification name is, and if all computers involved are aware of local naming services (WINS / DNS), then type in the computer’s name in the “Address:” slot and click **[Resolve>>]**. Once the computer is found, its IP address will appear as shown. If required, use **[>>Literal]** to transfer the name and address to their named slots. Click **[OK]**.

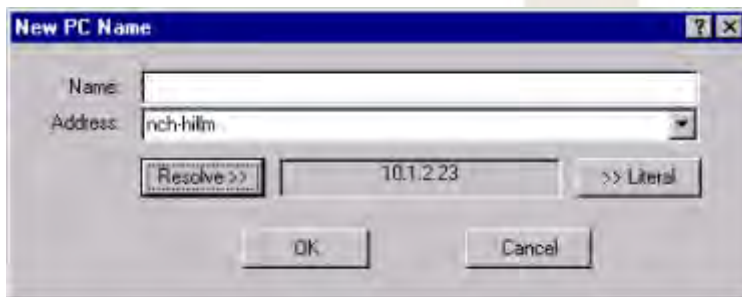

It is normal in a network for computers to be allocated new IP addresses when the PC is restarted. If the Client PC has a numerical entry for the address and the Server’s address has changed, it will not be able to re-locate it. If the Client PC has the name of the Server PC in the address slot, it will automatically search to re-locate the Server PC by name. Assuming it is found, the Client PC will obtain the Server PC’s

In the “Sockets” table click **[New]**.

Now check the “Client” radio button and select the “PC Name:” of the server.



Enter the number of the port on which the Server PC is presenting the data. Change the socket's default name if required. current address.

#### 3.4.3.1.2.2.The MultiFix Computer as a TCP Server

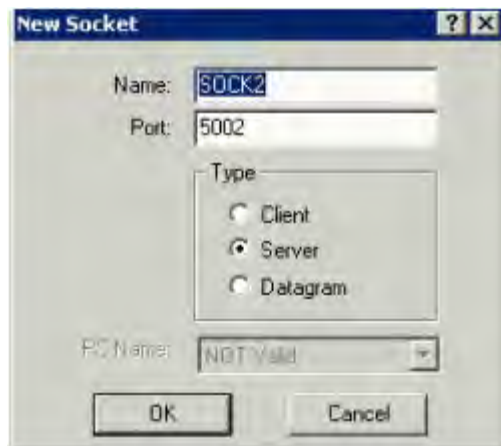

If the MultiFix computer is to be a server then there is no need to add the MultiFix computer to the PC table; the program already knows the computer's IP address. This can be seen in the window called up by "View" \ "Sockets".

In the "Sockets" table click **[New]**.

Give the socket a name and enter the Port number that the data will be output on. Click **[OK]** to exit.

### 3.4.3.1.2.3.Datagrams

It was explained in the section on [Sockets](#) that the User Datagram Protocol allows packets of data to be broadcast or to be sent to specific addresses without the overheads associated with the Transport Control Protocol.

#### BROADCASTING

MultiFix cannot give multiple addresses to packets of data so if information is to be made available to more than one computer in datagrams it must be broadcast on a particular port. A computer that is broadcasting on a port also listens to all data packets that are received on that port.

#### DATAGRAMS TO/FROM A SPECIFIC PC

To transmit to or to receive from a specific computer, (which may itself be broadcasting), a PC must be set up with a datagram socket where the port number and the PC are identified.

To broadcast datagram packets, click the "Datagram" radio button and select "Broadcast" from the "PC Name:" list.



To target one specific PC requires that the Internet address of that PC should already have been identified.

[Explanation of adding PCs.](#)

Once the PC has been entered in the "PC Names:" table click [New] in the "Sockets" table.

Give the socket a name, enter the Port number and in the "PC Name list select the PC.

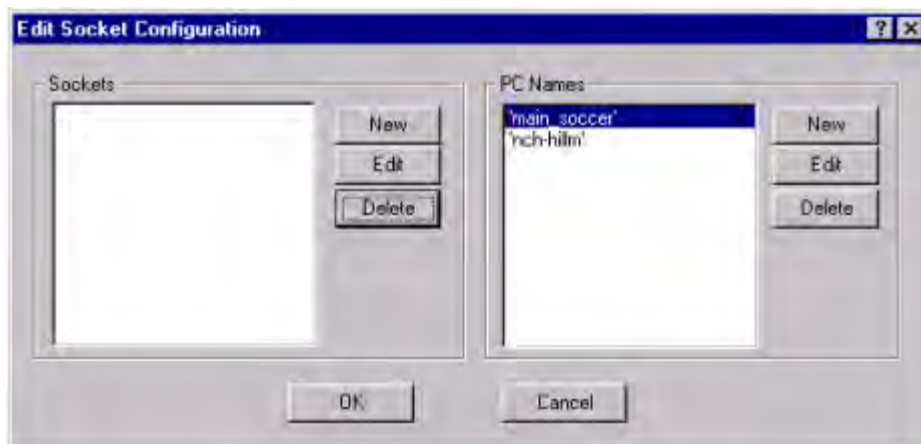

Click **[OK]** to exit.

Having set up sockets, the Edit Socket Configuration dialogue now shows the connection(s).

### 3.4.3.2. GPS Receiver

This calls up the Edit **GPS** Receiver.



Enter a receiver name in the **Name** box. If this is left blank MultiFix will automatically assign a suitable name (e.g. 4000 DS (Trimble)). As with other name labels the program does not use it for receiver recognition purposes.

In the **Type** section select the receiver that MultiFix is to use.

There are various possible selections.

- Z Family (Ashtech)\* are dual frequency receivers.
- DG16 (Ashtech)\* is a single frequency receiver
- G12 (Ashtech)\* is a single frequency receiver
- GG24 (Ashtech) \* is a single frequency receiver and is fitted in the Fugro 90964 units
- 4000 Series (Trimble) refers to either a single frequency 4000DS or a dual frequency SSE/SSI
- MS750 (Trimble) is a dual frequency receiver
- **BD750** (Trimble) is a dual frequency receiver
- 5700 (Trimble) is a dual frequency receiver
- BD112 (Trimble)\* is a single frequency receiver board fitted to the 90938/F112 Starfix decoder.
- DSM212 (Trimble)\* is a single frequency receiver.
- DSM (Trimble)\* is a single frequency receiver board fitted to 90938/M Starfix decoder.
- SK8 (Trimble)\* is a single frequency receiver board, but not recommended for offshore work. It has not been tested for full operation.
- Millennium (NovAtel)\* is a dual frequency receiver
- OEM4 (NovAtel)\* is a dual frequency receiver
- Topcon\* is a dual frequency receiver
- DSM232 (Trimble)\* is a dual frequency receiver
- Receiver Server is used when the data is not live from an external receiver but is taken from raw data log files.
- Receiver Verify is used for interfacing to the Receiver Verify (**RxV**) Module.

The [Scintillation Filter](#) option allows MultiFix to monitor the tracking of individual SVs. If symptoms of scintillation are detected the SV is disabled until tracking becomes constant again, giving a massive reduction in position instabilities. Since this may affect the number of available satellites users are advised to operate in Height Aiding mode when the [Scintillation Filter](#) is enabled.

In the **IO Channel** section select the port on which the receiver data is input.

The **Ancillary Receiver** option is used for synchronising GPS measurements over a data link. This is not currently used.

When one of the receivers marked above with an asterisk is selected, "Configure TSIP", "Configure Ashtech", "Configure Millenium", "Configure OEM4" or "Configure Topcon" becomes available under the

“Action” menu. This allows the receiver to be configured to output the correct data for MultiFix. The other [Trimble Receivers are configurable](#) using the Yellow box interface (“View” / “GPS” / “Receiver”).

Other manufacturers’ receivers require third party software to configure.

#### **3.4.3.3. Starfix Decoder**

The program will automatically take in any type 55 messages received on any **RTCM** IO Channel to which it has access, but will only take in Type 1, 2, 3 and 9 messages from Stations ID’s it is configured to accept. It is possible that an RTCM source may contain only Type 55 messages. Such a source will still need to be given an identity and an “IO Channel” but no station IDs. Each Type 55 message contains Ionospheric delay information from one reference station. The station ID is also in the message that is transmitted every 30 seconds. The sequence cycles through each of the available reference station, so if 7 stations are contributing Type 55 messages the information for each station will be updated every 3½ minutes.

In the same way, for an XP calculation the correction source will need to be given an identity and an “IO Channel” but no station IDs. MultiFix will then accept the Fugro Proprietary Type 11, 48, 49 and 50 messages necessary for this mode.

##### **3.4.3.3.1.New**

Click on “New” to make a connection to a **RTCM** source.

The image shows a software dialog box titled "New Starfix Decoder Input". It contains the following fields and controls:

- Name:** A text input field.
- Is Starfix SCF:** A checked checkbox.
- IO Channel:** A dropdown menu currently set to "None".
- Downlink Beam:** A dropdown menu currently set to "User Defined".
- Elevation Mask:** A text input field containing the value "10".
- Station:** A large empty list box with three buttons to its right: "New", "Edit", and "Delete".
- Starfix Decoder:** A section containing an "Exists" checkbox (unchecked) and an "IO Channel" dropdown menu (set to "None").
- Buttons:** "OK" and "Cancel" buttons at the bottom.

In the New Starfix Input dialogue give the RTCM source a **Name** and select the **IO Channel** of the port that the differential corrections are available on. Ensure the **Is Starfix SCF** tick box is correctly checked, depending on whether the connection is to a SkyFix or Starfix decoder.

If no name is given MultiFix will assign a suitable name automatically.

**Downlink Beam** contains a drop down list of all the satellite based Fugro RTCM sources. When one of those sources is selected, the dialogue is automatically populated with all the stations that carried by that system and the **[New]**, **[Edit]** and **[Delete]** buttons are lost.

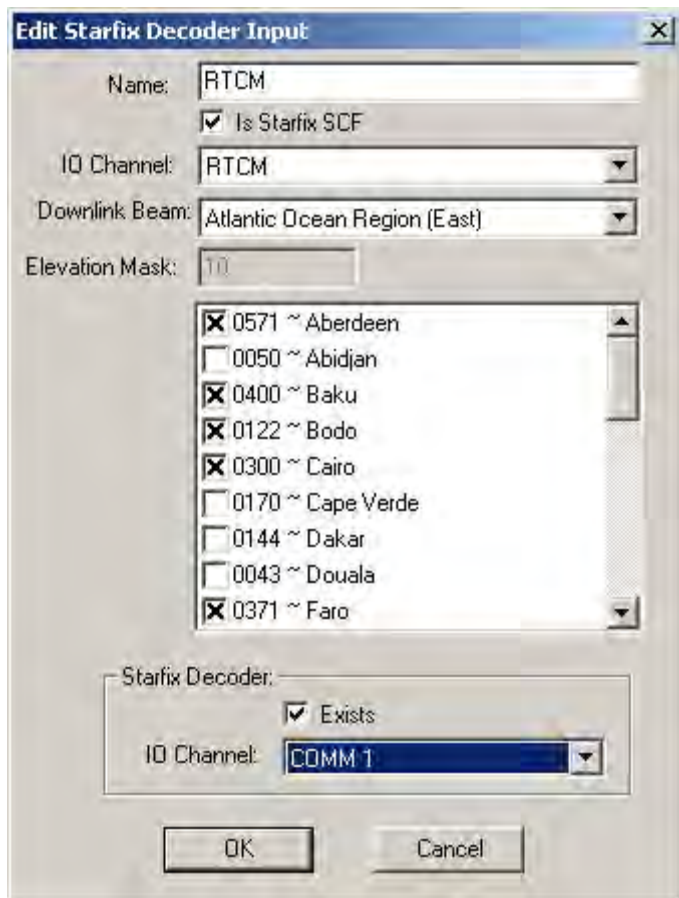

It is then necessary to switch on any stations to be used by clicking the check box next to the station's name.

If **SkyFix XP** mode is to be used then, along with a dual frequency **GPS** receiver, an RTCM input must be set up to obtain corrections. To do this enter a **Name**, **IO Channel**, and the relevant **Downlink Beam** (Refer to 'SkyFix XP Service Description' or [www.fugro.com](http://www.fugro.com) for the latest XP availability information). No reference stations need to be selected from the resultant list as only one set of XP corrections are available on each **Downlink Beam**. MultiFix will take in these messages as soon as this calculation is set up and "SkyFix XP" mode has been checked in the "Config" \ "Calc" \ "Settings" dialogue.

SkyFix XP corrections are broadcast using the following Fugro proprietary RTCM messages:

- Type 11 – **Almanac**.
- Type 48 – Absolute orbit, orbit rate, and clock corrections.
- Type 49 – Absolute orbit and clock corrections.
- Type 50 - Sub-metre clock corrections



If MultiFix is being used with a non-satellite based RTCM delivery system, or station names or numbers have been changed, a manually compiled list can be made. To add reference stations manually in the “Station” table of the New RTCM Input dialogue leave the **Downlink Beam** set to **User Defined** and click the **[New]** button.

The program requires the station ID code number. A name is also required for identity purposes but is not significant in accessing the data.

Assuming the RTCM source is outputting more than one station, after clicking [OK] to add the station to the list, repeat the process to add the other required stations.

If Iono free operation is planned, three criteria must be met to be viable.

1. A dual frequency receiver must be interfaced to MultiFix.
2. RTCM Type 1, 2 and 3 messages from one or more reference stations must be available.
3. Type 15 Ionospheric error information must also be available from the same RTCM reference stations.

**Edit Starfix Decoder Input**

Name:

Is Starfix SCF

IO Channel:

Downlink Beam:

Elevation Mask:

Station

0571 ~ Aberdeen	
0400 ~ Baku	
0122 ~ Bodo	
0300 ~ Cairo	
0371 ~ Faro	
0410 ~ Istanbul	
0280 ~ Las Palmas	
0521 ~ Leidschendam	
0351 ~ Malta	

New  
Edit  
Delete

Starfix Decoder:

Exists

IO Channel:

OK Cancel

For Premier calculations there is no need to set up 6 reference stations if only one of them outputs Ionospheric error information as this will be the only station used in that mode.

If a SkyLink calculation is to be used however then both dual and single frequency stations can be combined. [More details of Calculation type.](#)

If a Mark 5, 90938 or 2403 Decoder is used to supply the RTCM corrections then it is possible to configure the decoder to output Bit Error Rate and Signal Voltage status information on a separate port (usually Port 4). If this data is required then check the **Exists** box and select the port receiving the data. This in turn activates the “Starfix Decoder” menu item under “View” \ “Corrections”.

Click **[OK]** to accept the correction source.

If there is more than one RTCM correction delivery system add another new source and set up using either of the two procedures above.

Assuming the RTCM interface has been established, the messages from the [RTCM source](#) can be viewed to see the Reference Station numbers that the program is receiving.

#### **3.4.3.3.2.Editing and Deleting**

With an **RTCM** source (or sources) now defined, when “Config” \ “Starfix Decoder” is selected, the name (or names) given to the RTCM source(s) now appears in the sub-menu under the “New...” menu item.

If the set up requires changing then highlight the name of the source and then select the “Edit...” option.

If the RTCM source is no longer in use, again use “Config” \ “Starfix Decoder” \ “<name>” and select “Delete”. You will be asked to confirm or cancel the deletion. Be aware that an inappropriate deletion could severely impact on the correct operation of the program.

#### **3.4.3.4. Calculations**

##### **3.4.3.4.1.Settings**

Enter a Trial Point position in the **Latitude**, **Longitude** and **Height** fields. This must be within, at the most, half a degree of latitude and longitude from the users current position.

Settings

Latitude: 52°35'26.729"N      Height above MSL: 62.4  
Longitude: 001°42'39.355"E      Height SD: 100

Geoid Separation  
 EGM96 Model  
 User defined (m) 0

Elevation  
Mask: 10  
Delta: 5

Calculation Mode  
 SkyFix L1  
 SkyFix XP  
 SkyFix L1/L2

SkyLink  
Critical Dist (Km): 300

OK      Cancel

Both the **Latitude** and **Longitude** fields allow a flexible form of data entry. The N/S or E/W can be entered at the start or end of the value. A space, comma or colon can separate the degrees, minutes and seconds values.

If the incorrect Trial point is entered (or no value at all) then MultiFix will attempt to derive an approximate position either from the current calculation, if available, or directly from the **GPS** Receiver. In order to obtain a position from the GPS Receiver position outputs should be enabled on the data port being used by MultiFix. See details of how to [configure the GPS Receiver](#).

MultiFix includes the **EGM96 Geoid / Spheroid** separation model. By default this model is used for all calculations. The separation is computed every epoch and the figure used within the calculation is the exact figure for the current location.

It is also possible to disable this model and apply your own Geoid / Spheroid separation value by selecting the **User Defined** radio button. This should only be used where the EGM96 model is not suitable, such as on locked waterways where the sea level is not coincident with the local Geoid.

The Geoidal height based on the Geoid / Spheroid separation is used in all displays in MultiFix unless otherwise stated. However, using the wrong Geoid / Spheroid separation will only affect the calculation process if height aiding is enabled.

Enter the height of the antenna above the ships water line, or Mean Sea Level (MSL), in **Height above MSL** box. This is approximately equal to the Geoid. The **Height above MSL** and the **Height SD** are used if the calculation is selected to be altitude aided, see 4.3.3.4.3. The smaller the **Height SD** value the higher weight is given to the **Height above MSL** value. The **Height SD** is dependant on the confidence of the initial antenna height measurement and the expected variation in antenna height due to vessel movement caused by swell and changes in draught.

**Remember, when surveying on landlocked or inland waterways, the mean water level may be many metres above or below the Mean Sea Level/Geoid.**

In the **Elevation** table is **Mask** and **Delta**. **Mask** sets the minimum elevation at which a satellite will be used by the program. Do not set an elevation mask in this dialogue lower than the elevation mask used in the GPS receiver. Setting a lower mask does not change the receiver configuration. Setting a higher mask may be useful if SVs at slightly higher elevations are suffering from poor signal to noise ratios.

**Delta** is the number of degrees above the minimum elevation a satellite must be before it is fully weighted in a computation.

When using a **SkyFix XP** calculation the **Mask** is hard coded to 5° and the **Delta** to 0° in order to have a minimum of 5 SV's available. Setting the **Mask** and **Delta** will change the mask values for the **SkyFix L1** and **SkyFix L1/L2** calculations only.

When setting up a SkyLink Mode calculation MultiFix will only use the single frequency corrections for stations that are within this range. This allows the user to add single frequency stations that are close to the work area (e.g. DeltaFix and IALA beacon stations), and are not significantly affected by differential ionospheric delays, into a dual frequency calculation. The **SkyLink Critical Distance** sets the threshold distance that MultiFix will use to switch from single to dual frequency calculation for each individual station. The default value is 300km.

The Trial Point is used when the Offsets Window is viewed. One of the options when right clicking on that window is to have the centre point at a fixed co-ordinate and to view the calculated positions with reference

to that trial point. In this case the position will need to be entered with the highest possible precision to obtain realistic offset views.

If a Dongle is present, then both the **SkyFix L1/L2** and **SkyFix XP** check boxes will be enabled. If a Dongle isn't being used, then these tick boxes will remain disabled until the appropriate [License Keys](#) have been installed.

If the **SkyFix L1/L2** box is checked the L1/L2 dual frequency positioning mode is enabled.

If the **SkyFix XP** box is checked the XP positioning mode is enabled.

This reveals the additional menus

["Config" / "Calc" / "SkyFix XP..."](#)

["View" / "Corrections" / "Orbit Data"](#)

and

["View" \ "Calc" \ "XP Offsets"](#).

See [XP Offsets](#)

When exiting XP or L1/L2 positioning mode the following warning is issued:

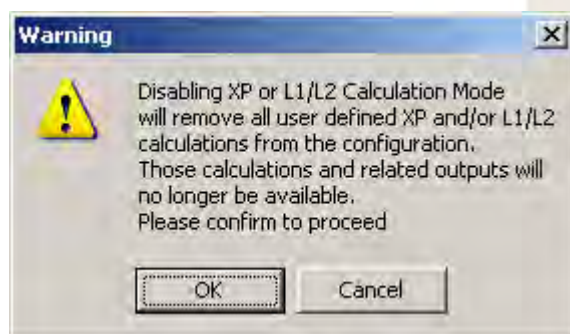

#### 3.4.3.4.2.Skyfix XP

This menu becomes available when **SkyFix XP** mode is enabled in ["Config" \ "Calc" \ "Settings"](#).

The XP calculation will automatically start when XP mode is selected, assuming a valid **GPS** Receiver and decoder have been configured.

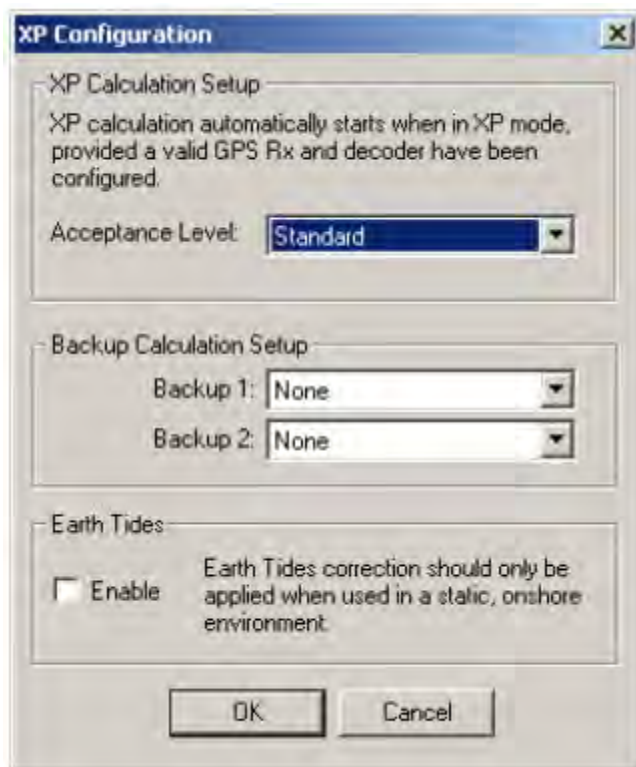

The **Acceptance Level** is used to set up how quickly the XP solution will begin outputting a solution. There are four options:

- **Always** – The solution will always be output regardless of the level of XP solution convergence.
- **Loose** – This will output a position when the XP solution has converged to better than 2.0 metres.
- **Standard** – This will output a position when the XP solution has converged to better than 1.5 metres.
- **Accurate** – A position will be output when the XP solution has converged to Decimetre level.

In the **Backup Calculation Setup** section, **Backup 1** and **Backup 2** solutions can be selected if previously configured. These solutions will be used whilst the XP solution converges to the level chosen above, or if the solution falls below the selected convergence level during operation. The [“View” \ “Calculation” \ “Status”](#) window shows the current solution being output.

**Earth Tides** are slight bulges in the areas of Ocean’s, or Earth’s, surface that faces the Sun and Moon. This is due to the gravitational attraction of these solar bodies. The bulge can be a few metres in oceans but is less pronounced on land, tending to give “Earth Tides” in the order of a few centimetres. The **Earth Tides** box should only be checked when using SkyFix XP for static onshore applications. This allows MultiFix to compensate for this effect.

For offshore projects ensure “Earth Tides” remains unchecked.

### 3.4.3.4.3. New Calculation

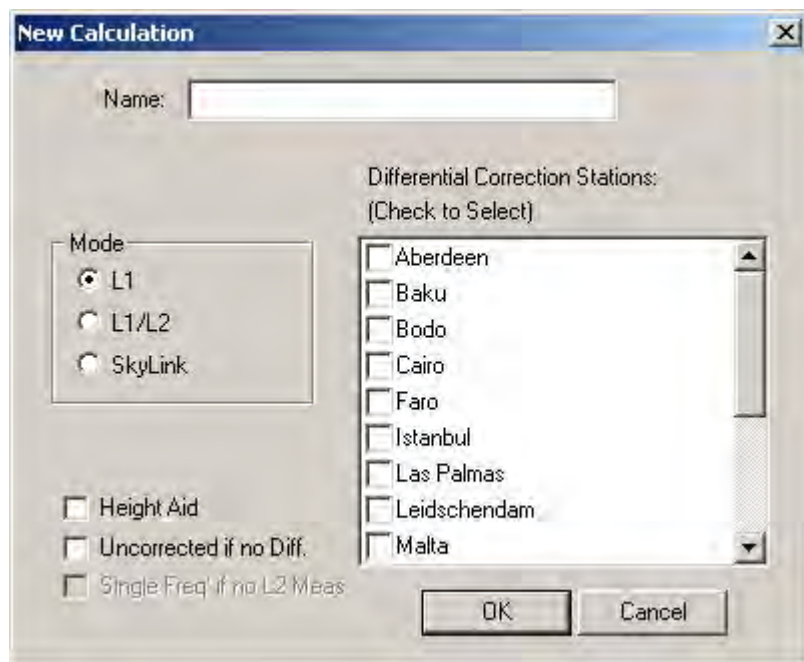

The dialogue will contain all the **RTCM** reference station names entered when defining the RTCM source(s). If the same station was selected twice it will appear twice.

Give the Calculation a **Name** and select the **Differential Correction Stations** to be used in forming the solution. If no reference stations are selected the program will produce a non-differentially corrected stand-alone solution. If no name is given MultiFix will automatically generate an appropriate name for the computation based on the configuration of the solution

e.g. Network - L1L2 – H+, meaning a network solution using **L1** and **L2** with height aiding enabled.

Click the type of calculation required.

**L1** creates a single frequency **DGPS** solution using the Klobachar Ionospheric model.

The following two options will only be available if **SkyFix Premier** mode is enabled in “Config” \ “Calc” \ “Settings”.



**L1/L2** creates an Ionosphere-Free DGPS solution. It presumes there is access to dual frequency data from a GPS receiver and Type 1 and Type 55 messages from at least one of the selected reference station(s). An L1/L2 solution will not use corrections from reference stations where only Type 1 or Type 55 messages are received, both must be available.

**SkyLink** allows MultiFix to add single frequency stations close to the user to a dual frequency calculation. Selection is based on the range to the station, as defined under the "Config" \ "Calc" \ "Settings..." configuration page. This function allows users to mix single and dual frequency corrections in a single calculation.

If SkyLink mode is selected all stations within a specified range threshold (the SkyLink Critical distance as defined in section 4.3.3.4.1) will be used. When a station lies outside of the range threshold it will only be used in dual frequency mode. Therefore, if a station only provides single frequency data and is outside of the critical distance it will not be used by MultiFix. If a station is within the range it will ONLY be used in single frequency mode.

This is because there will be no ionospheric range error (sometimes called gradient effect) on the corrections as the ionospheric delay will be nearly the same at both the reference station and the user location. This avoids the use of the noisier L2 measurements and will result in a smoother positioning performance.

**NOTE:** Single Frequency Stations in excess of 300km will have a greater ionospheric range error that will bias the position calculation and negate any beneficial reduction of the L2 noise.

Click the **Height Aid** box if the calculation is to be aided by the height entered in the "Config" \ "Calc" \ "Settings..." configuration page.

In the event that all RTCM corrections are lost, if **Uncorrected if no Diff.** is ticked, the calculation will automatically switch to a standalone solution. Any outputs based on the calculation will continue with the differential flag in the messages set to non-diff. If the box is not ticked then loss of RTCM will mean the calculation will fail and any outputs based on the calculation will stop. If an L1/L2 calculation is selected, then ticking the **Single Freq' if no L2 Meas** box ensures the calculation continues as L1 only if no L2 measurements are being received.

Clicking **[OK]** exits the dialogue and causes the calculation to commence.

#### 3.4.3.4.Editing and Deleting

Once a calculation(s) has been defined the “Config” \ “Calc” \ “DGPS Calc” sub-menu contains the name (or names) of the calculation(s). If a name is highlighted the calculation can be “Edited...” or “Deleted”. Deletion requires a confirmation.

Assuming the set up has been accomplished correctly the program will now attempt to receive data and form a position solution(s).

At this point it is recommended that the configuration file be [saved](#).

#### 3.4.3.5. Output

If a position is to be supplied to another computer then an output must be defined.

Refer to [Output Pre-Selection](#) for the fact that MultiFix must have accessed the \*.zpo library files before it can create the output formats listed below.

MultiFix can create:

- 9 different Standard outputs, Trimble, DNAV, DNAV – Nautis Modification, **ZeroLink**, Fugro **UKOOA**, Geco UKOOA, Geco UKOOA Version 2, Fugro XP Expanded and Fugro XP Concise.
- 10 different **NMEA** outputs, GGA, GGA + VTG, GLL, **RTK**, ZDA, DPGGA and GGA (LDA), GSA, GST and GSV.

Note that the RTK sentence is a Fugro proprietary sentence. It has been included for future development but should not be used until Real Time Kinematic computations are being performed within MultiFix. The facility to create an **RMC** message is described under the User Modified section see page 69.

- 2 different Projection Grid (**UTM**) outputs known as Syledis and GEM 80 DP
- 1 Propriety XML Data output called DGPS\_IS

The DPS\_IS sentence is a Fugro proprietary sentence. It has been included for use with Fugro monitoring software.

[APPENDIX A - DATA OUTPUT STRINGS](#) has descriptions of all the output formats.

**Note:** When there is a time tag in a position output string, the time output will be the time of the fix, i.e. when the position calculation was performed, unless otherwise stated. This may be up to 1 second old by the time of output. MultiFix does not predict the position contained in the string to the time of output. (This does not apply to the [NMEA ZDA](#) sentence where the time in the sentence is that of the moment of output). The time standard used in each output that contains time will be as defined by the format of the output, i.e. **UTC** or **GPS** time.

#### 3.4.3.5.1. Standard Outputs

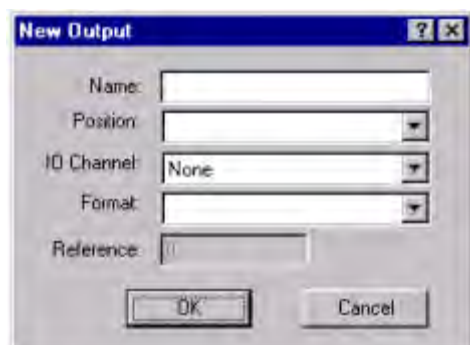

Each output can only contain the results from a single calculation so the output could perhaps be given the same name as the calculation. If no name is given MultiFix will assign the name of the selected calculation to the output.

In the "Position:" section select the calculation from which the position is to be taken.

In the "IO Channel" section select the output route. Be aware that the list will still contain the channel that may already have been assigned to the **GPS** Receiver. As the communication with the GPS receiver is two-way it is not a valid channel for the position output strings.

Select the desired format for the output data string.

If the selected format is Trimble, Geco **UKOOA**, Geco UKOOA version 2 or **ZeroLink**, the "Reference" edit control can be set. These formats allow an additional identifier for differentiation purposes. If Trimble or one of the Geco UKOOA formats is selected the reference number should be in the range 00-99. If ZeroLink, then the number should be in the range 00-31.

ZeroLink is the format for communicating with other applications in the Zero suite of programs.

Warning, if ZeroLink is selected do not attempt to output via a **COM port** as the message is too large and will have a detrimental effect on the performance of the program.

Fugro XP Expanded and Concise are proprietary Fugro output formats. The XP strings have been designed to reflect the operation of the SkyFix XP calculation in MultiFix and include the statistical parameters that are relevant for this type of calculation. An important characteristic of SkyFix XP is that the XP calculation can fall back to normal DGPS calculations. Hence, the calculation can switch between a Kalman Filter approach and a Least Squares approach. This has an effect on what statistical parameters are relevant and available. The content of the end of the Expanded string, containing statistical parameters, therefore depends on the calculation mode used to derive the position.

The Concise string gives users the option to use a basic position & QC output, the Expanded string is required to have access to more satellite related QC information.

The Fugro Corrections string gives the users information on the RTCM configuration.

Click **[OK]** to activate the output.

#### 3.4.3.5.2.Approved NMEA Sentence Outputs

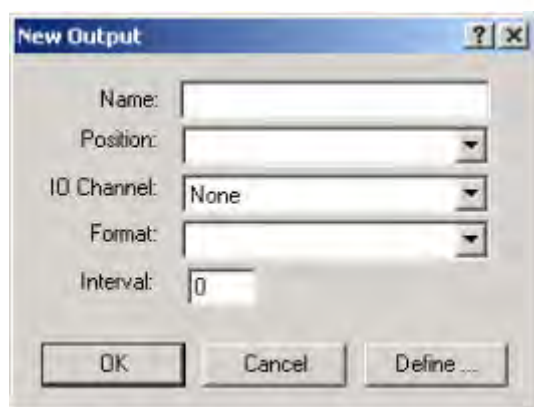

As with the Standard outputs give the output a “Name”, a source computation in “Position” and assign an “I/O Channel” for output.

In the “Format” slot select the output format(s) required.

### Sentence Formatter

GGA	= Global Positioning System Fix Data
VTG	= Course over Ground and Ground Speed
GLL	= Geographic Position – Latitude/Longitude
<b>RTK</b>	= Real Time Kinematic (not approved, Fugro proprietary, should not be used until MultiFix supports RTK computations).
ZDA	= <b>UTC</b> Time and Date
DPGGA	= <b>IMCA DGPS</b> DP Interfacing Format, a standard format providing suitable data for DP systems.
GGA (LDA)	= This is a modified version of the GGA string for interfacing to specific systems that cannot handle a latency figure of more than 10 seconds.
GSA	GNSS DOP and Active Satellites
GST	GNSS Pseudorange Error Statistics
GSV	GNSS Satellites in View (L1 SNR values)
GSU	GNSS Satellites in View (L1 & L2 SNR values)

The “Interval” option allows the user to specify an interval (in seconds) between GGA outputs, to be used if an output rate of less than 1Hz is required.

**Please note that setting is an actual interval, the software will supply the first available fix after the specified interval, so if the calculation processes is running slowly the difference in times tags may not equate to exactly the specified interval.**

#### 3.4.3.5.3. User Modified NMEA Sentences

There is an added facility to create a user modified **NMEA** output that, while retaining the essential format, is customised for the recipient. In the New output dialogue click [Define...].

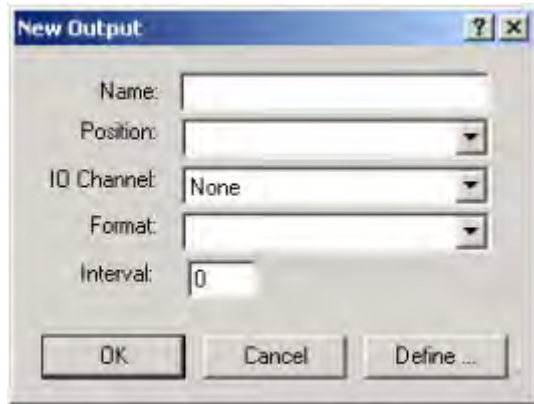

To create a new User Defined NMEA output click [New].

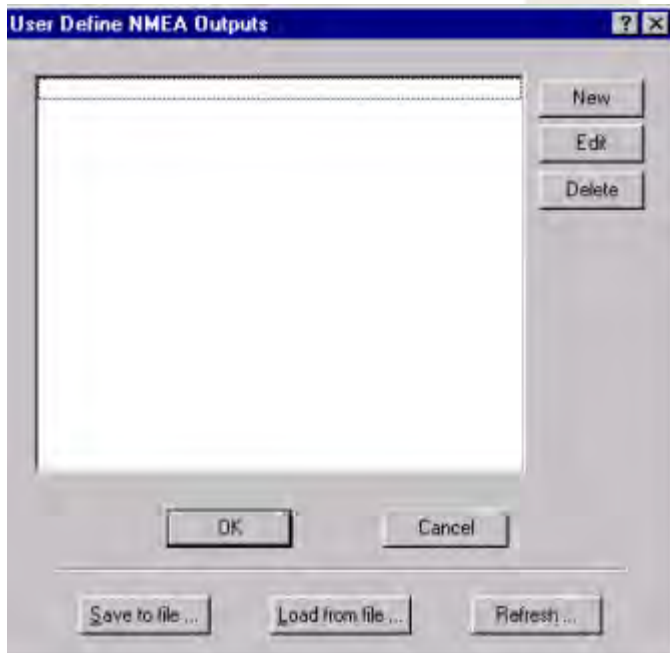

Give the string a title then click [New].



In the “Message” group click the NMEA sentence that is to be the basis for the output string. (Notice that **RMC** is an option not previously seen. RMC stands for the “Recommended Minimum Specific **GPS**/Transit Data” sentence).

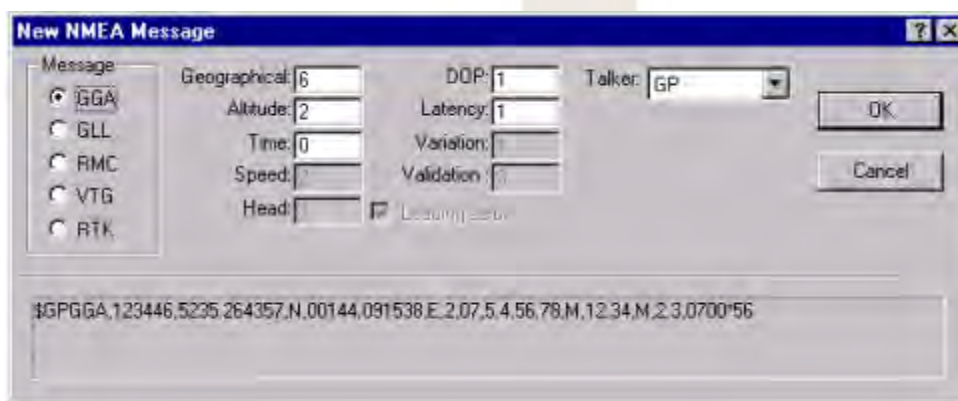

The lower display table will show the construction of whichever sentence is selected.

The rest of the dialogue will modify the basic sentence. Most fields refer to the number of decimal places associated with each field but if RMC or VTG is selected there is the added facility to have or suppress leading zeros to the course made good.

At the start of the sentence the first character which is a \$ is a two letter talker identifier mnemonic followed by the three character Sentence Formatter. The two-letter talker identifier can be:

GP	= Global Positioning System
SN	= Electronic positioning system, other/general

IN	= Integrated Navigation
RL	= Not NMEA standard, presumably Fugro Ltd
??	= ??

If a change is made to the default format of the sentence, click in another active slot to see the change occur in the lower display table.

Once one NMEA sentence has been modified, another can be added.

[OK] exits to the User Define NMEA Outputs dialogue.

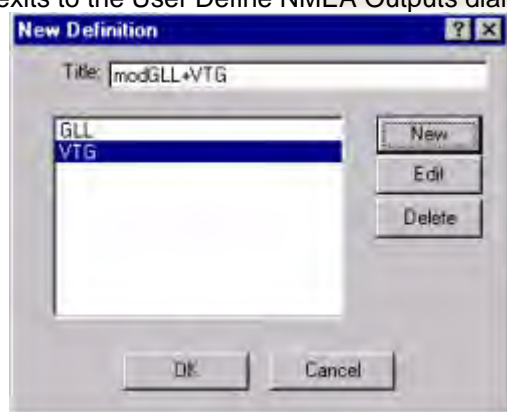

There are three buttons in this dialogue.

**[Save to file...]**

**[Load from file...]**

and

**[Refresh...]**

**[Save to file...]** opens the Save definition to file dialogue. Enter a name for the Fugro Definition Format file and click **[Open]**

**[Load from file...]** opens the Load definition from file dialogue. The current \*.rdf files will be listed. To revert to previously defined and saved user output sentences click **[Open]**.

**[Refresh...]** deletes all User Defined Outputs.



Once a user defined NMEA output has been created / loaded, its title is added to the approved NMEA sentence list so it can thereafter be selected for output.

#### 3.4.3.5.4.UTM Outputs

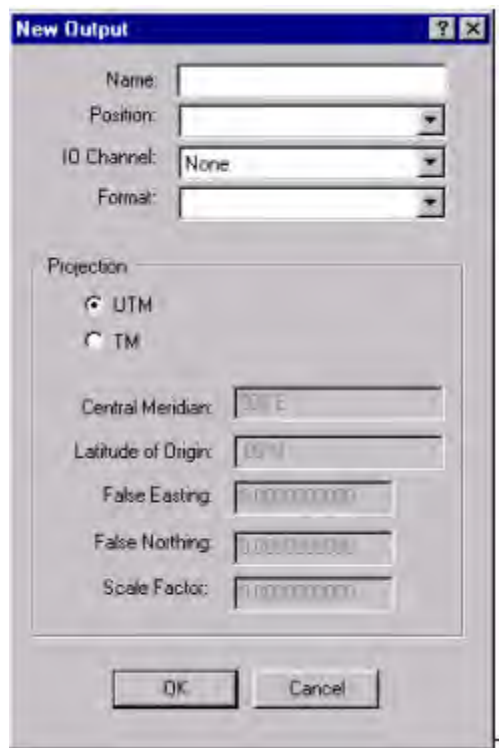

As with the Standard and **NMEA** outputs give the output a “Name”, a source computation in “Position” and assign an “I/O Channel” for output.

Select the required “Format” (“Syledis” or “GEM 80 DP”)

In the “Projection” table if “UTM” is clicked the co-ordinates in the string will be for the **UTM** Zone relevant to the current position.

If “TM” is clicked the edit control slots, which are shown greyed out, become active and the parameters can be defined.

Grid co-ordinates will be based on the WGS 84 ellipsoid. There is no ellipsoid/datum transformation facility in MultiFix.

### 3.4.3.5.Editing and Deleting

Once an output has been defined the “Config” \ “Output” sub-menu, as well as having “New...” also has the output name (or names).

If a name is highlighted, the calculation can be “Edited...” or “Deleted”. Deletion requires a confirmation.

### 3.4.3.6. P2/94 Output

The “P2/94 Output” will only be visible if “P2/94” has been enabled in the “Options” menu.

MultiFix has the capability to output raw GPS measurements, Ephemeris and RTCM corrections in P2/94 format. The P2/94 format is used for the exchange of raw positioning data and is recommended by UKOOA for general use in the Oil and Gas, Exploration and Production industry.

The full P2/94 format is extensive and covers a wide-range of equipment. MultiFix only outputs P2/94 records that are relevant to positioning, these are as follows:

T55##	Inter-event network GPS Observations (## = Observation Type*)		
T56##	Network GPS Observations continuation record (## = Observation Type*)		
T6310-17	Updated GPS ephemerides & clock		
T6320	Updated GPS UTC parameters		
T6321-22	Updated GPS ionospheric model parameters		
T65##	Inter-event Differential correction data (## is the differential Correction Source (DCS) Identifier) RTCM Type 1, Type 2 and Type 3 messages.		
*Observation	##20	–	GPS carrier-phase
Type:	##22	–	GPS carrier-phase
	##23	–	GPS instantaneous Doppler frequency

It is necessary to have already configured the GPS Rx and, if T65 records are required, a Starfix decoder as well prior to creating a P2/94 output.

As with the Standard outputs give the output a “Name”, and assign an “I/O Channel” for output.



Next select the differential reference stations that are required to be output by clicking **[New]**.

All the reference stations that were selected in the Starfix decoder set-up will now be available in the drop-down box.



Select a station and then in the “User Def ID” enter a unique ID number to a maximum of 99 (MultiFix will not allow duplicate ID's). The ID does not have to represent the Starfix ID, but is used to identify the individual reference stations in the P2/94 T65 records. Once completed select **[OK]**. This process has to be repeated for each reference station that is to be included in the P2/94 output.

To edit a station already included, highlight the station in the list in the “Edit P2/94 Output” dialogue and click **[Edit]**.

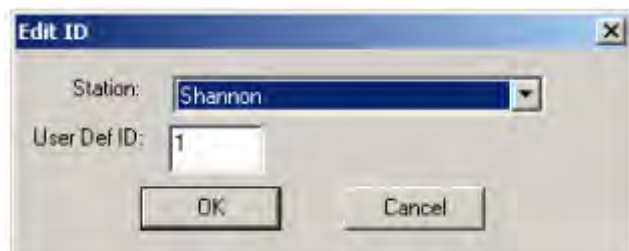

The "Edit ID" dialogue will appear. Make the necessary changes and click **[OK]** when completed.

From the "Edit P2/94 Output" dialogue click **[OK]** to activate the output and complete the set-up. By clicking **[Cancel]** any changes will not be saved.

#### 3.4.4. Action

The Action menu item "Configure TSIP" will only appear if the **GPS** receiver selected uses the **TSIP** communication protocol, i.e. DSM (Trimble), BD112 (Trimble) or SK8 (Trimble).

The "Configure Ashtech" option will only be displayed if an Ashtech receiver is selected, i.e. Z Family, DG16, G12 or GG24.

In the same way the "Configure Millennium" and "Configure OEM4" options will only be displayed if a NovAtel Millennium or OEM4 receiver is selected.

##### 3.4.4.1. Restart Sockets

On occasion heavy network traffic may lock up any or all TCP/IP socket ports. This option will re-initialise all currently open sockets without having to restart the software or editing the configuration files.

##### 3.4.4.2. Collect Almanac

MultiFix will not work without almanac data. When the program is first opened there is an automatic series of requests for almanac data to the **GPS** receiver. If the receiver is not available to the program at that time there will be no almanac data. Once communications with the receiver have been established a request for almanac data can be forced using this facility.

Current almanac information is displayed under ["View" \ "GPS" \ "Almanac"](#).

Without a forced almanac update, almanac information would still be acquired albeit slowly. It can take up to 30 minutes to acquire all the information as it is updated at 1 SV per minute.

### 3.4.4.3. Update Differential Stations

This allows the user to update the current list of beams and reference stations known to MultiFix, by either browsing to an existing network file (extension **.SFX**) or selecting the internal default network. Upon launching the MultiFix application, it will obtain its beam and reference station information by reading an installed version of the network file. The default network is coded within MultiFix, but it's recommended that the user browses to a specific network file. The GeoSky application can be used to download the very latest version of this file from the internet.

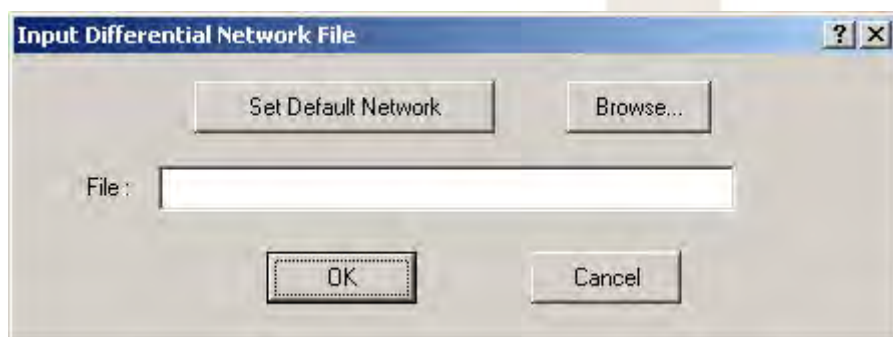

Upon selecting OK, the user is provided with the following warning.



Changes such as the addition or deletion of beams and stations caused by reading a new **.SFX** will be reflected when configuring the [Starfix Decoder](#). Any stations that had been used in calculations that were not present in the selected **.SFX** file will now be removed.

#### 3.4.4.4. Reset SkyFix XP Filter

This function empties all values from the Kalman Filter used in the SkyFix XP position calculation. A warning window will appear asking for confirmation prior to performing the function.

Be aware that if the filter is reset then the XP solution will need to re-converge before it can be used.

#### 3.4.4.5. Configure TSIP

This facility instructs a Trimble Standard Interface Protocol (**TSIP**) **GPS** receiver to output the information MultiFix requires. This will need to be done each time power to the receiver is cycled. (If a 90938 has a BD112 or DSM fitted there is battery back up on the receiver when the 90938 is switched off).

This display is only visible when a TSIP controlled GPS receiver is selected.

##### 3.4.4.5.1. Default TSIP Configuration

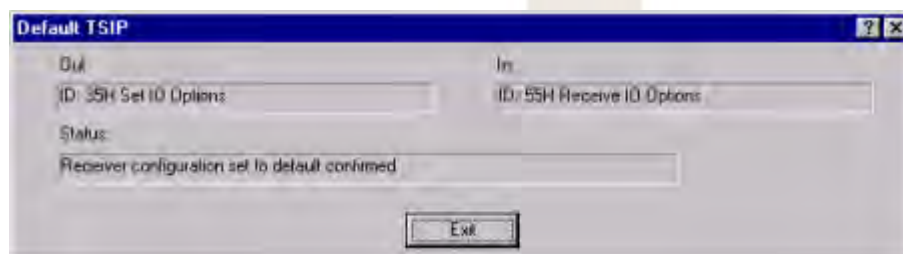

Accessing this dialogue causes the program to immediately send two configuration messages, a Synchronise Measurements message and an I/O Options message. As soon a response from the receiver is received the dialogue above will be shown. If there is no link between the computer and the receiver the dialogue will state “awaiting acknowledgement”, “unable to set default parameters” or “waiting to reset default receiver configuration”. Every 5 seconds it will retry to configure the receiver until **[Exit]** is clicked.

##### 3.4.4.5.2. Advanced\_TSIP\_Configuration

As with the default configuration, as soon as this dialogue is accessed the program will try to establish communication with the receiver and try to configure it with the default configuration.

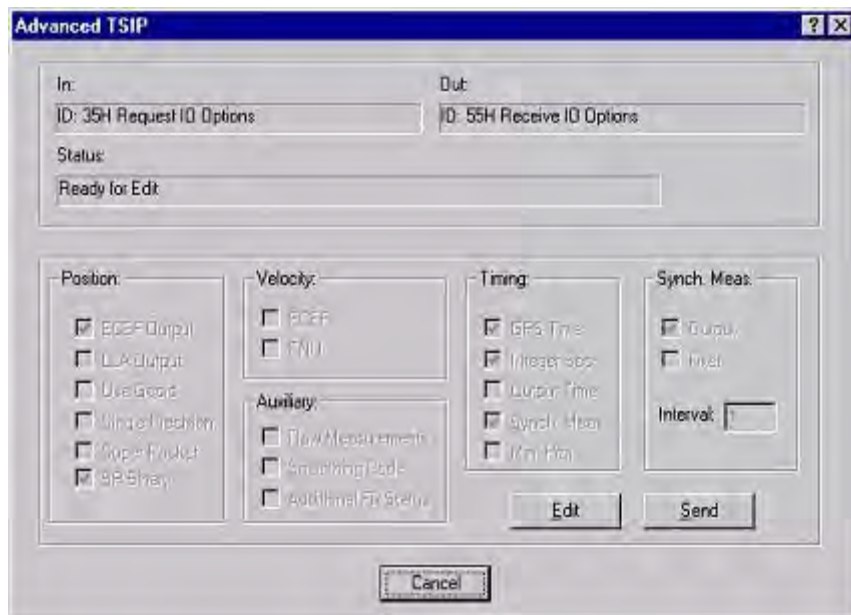

To change the configuration, click the **[Edit]** button.

The program provides a warning which must be read carefully. Clicking **[OK]** activates the Edit Controls in the “Position”, “Velocity”, “Timing” “Auxiliary” and “Synch. Mess.” Tables.

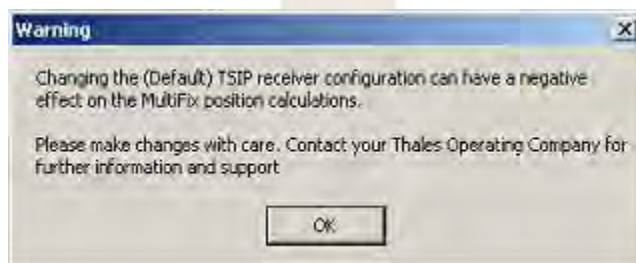

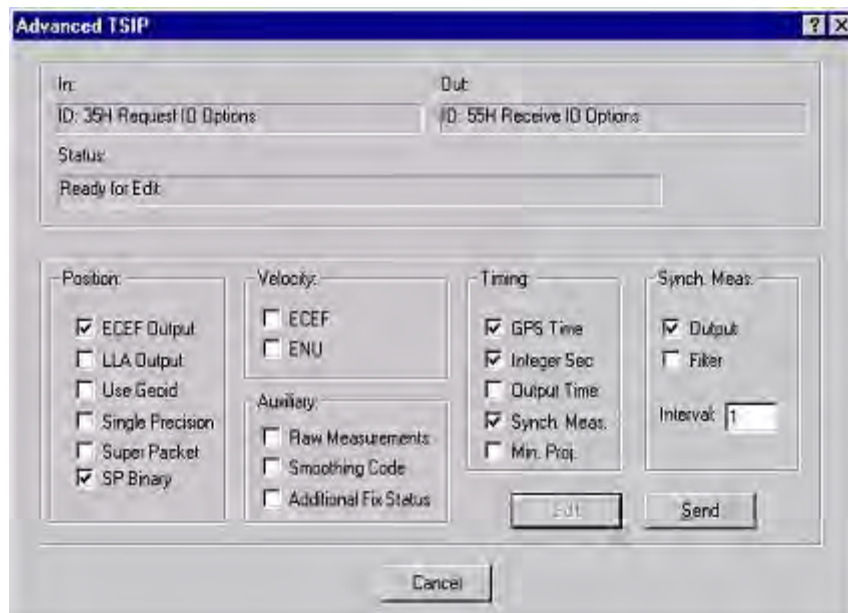

For a full explanation of the options available the reader is directed to the Trimble TSIP Reference document, Trimble Part No 34462-00. The latest revision that is held by the TSG is Rev B dated Feb 1999.

#### 3.4.4.6. Configure GPS Receiver



If an Ashtech or a NovAtel GPS receiver has been selected for use with MultiFix then the "Configure Ashtech", "Configure Millennium" or "Configure OEM4" dialogue will be made available.

Assuming serial communications have already been established an Ashtech or NovAtel GPS Receiver can be configured from within MultiFix.



See [Ashtech \(Thales Navigation\) Receivers](#) or [NovAtel Receivers](#) for details on how to establish a communication link with the GPS Receiver.

#### 3.4.4.6.1. Default Receiver Configuration

Clicking on the **[Set Default Config]** button will send the basic command needed to configure the selected unit for use with MultiFix.

#### 3.4.4.6.2. Advanced Receiver Configuration

The **[Advanced Config]** Button will call up a control menu.

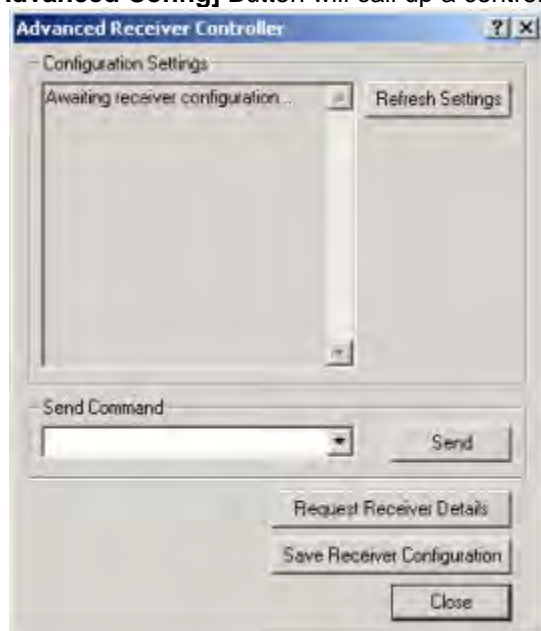

**[Refresh Settings]** will update the display.

**[Request Receiver Details]** will interrogate the GPS receiver settings and send commands to the unit.

**[Save Receiver Configuration]** will save the current setting to the battery powered RAM on the receiver circuit board.

The "Send Command" dialogue allows the user to send additional commands to the GPS receiver. Please refer to the appropriate Ashtech or NovAtel handbooks for details of the available commands.

### 3.4.4.7. SV Status

The SV Status dialogue can also be called up by clicking



It shows a list of all the SV numbers. Numbers that are greyed out indicate that there is no current *almanac* data for them. Numbers with a yellow cross through them indicate that the satellite is unhealthy and will not be used in the computations.

If a number is clicked then that number will be shown with a red cross and the satellite will be excluded from all computations until re-enabled.

The SV Status dialogue is a modeless dialogue and unlike standard dialogues, program control can still be exercised while it stays open.

### 3.4.4.8. Force P294 Ephemeris/Almanac Update

This action only becomes available once the [P2/94 Option](#) has been selected. As the title suggests, it causes the forced output of the current ephemeris and almanac parameters in [P2/94](#) format.

### 3.4.5. View

The items show in brown will only appear if pre-conditions have been met.

“Files” will only appear in replay mode.

“Datagrams” only appears if a **UDP** socket has been defined

“Receiver” only appears if a 4000 Series (Trimble), MS750 (Trimble) or **BD750** (Trimble) is the selected **GPS** receiver type.

“Iono Filter” will only appear if one of the computations is designated as “Premier”.

“Starfix Decoder” only appears if it has been selected that one or more **RTCM** source(s) is a Starfix Decoder and it is outputting test data.

Right-mouse clicking most windows allows the user to customise the display. Where that customisation is specific to the view window it will be mentioned in the relevant section in the manual. Several windows share the same two facilities of “Copy” and to “Save As...”.

“Copy” places a bitmap of the window onto the clipboard from where it can be pasted into another application.

“Save As...” allows an html or bitmap file of the view window to be saved. By default the files will be placed in the folder that contains the MultiFix configuration file. The bitmap files are saved as \*.bmp images but the html file does not contain images but instead has links to the images, so when MultiFix saves an html file the bitmaps are saved as well. When an html file is saved a Zero HTML Association file is also created. If the html file is deleted the associated bit maps are deleted as well

In common with many Windows programs, MultiFix allows display windows to be moved outside the area displayed by the monitor. The application workspace automatically extends and scroll bars are provided. The scroll bars allow the display area to move around the extended application workspace. There is no limit on the number of windows of any type that can be open in the application workspace. Multiple copies of the same window type can be open. Indeed it will be seen that once a window is open some types of window allow further selection of the data that is to appear in them.

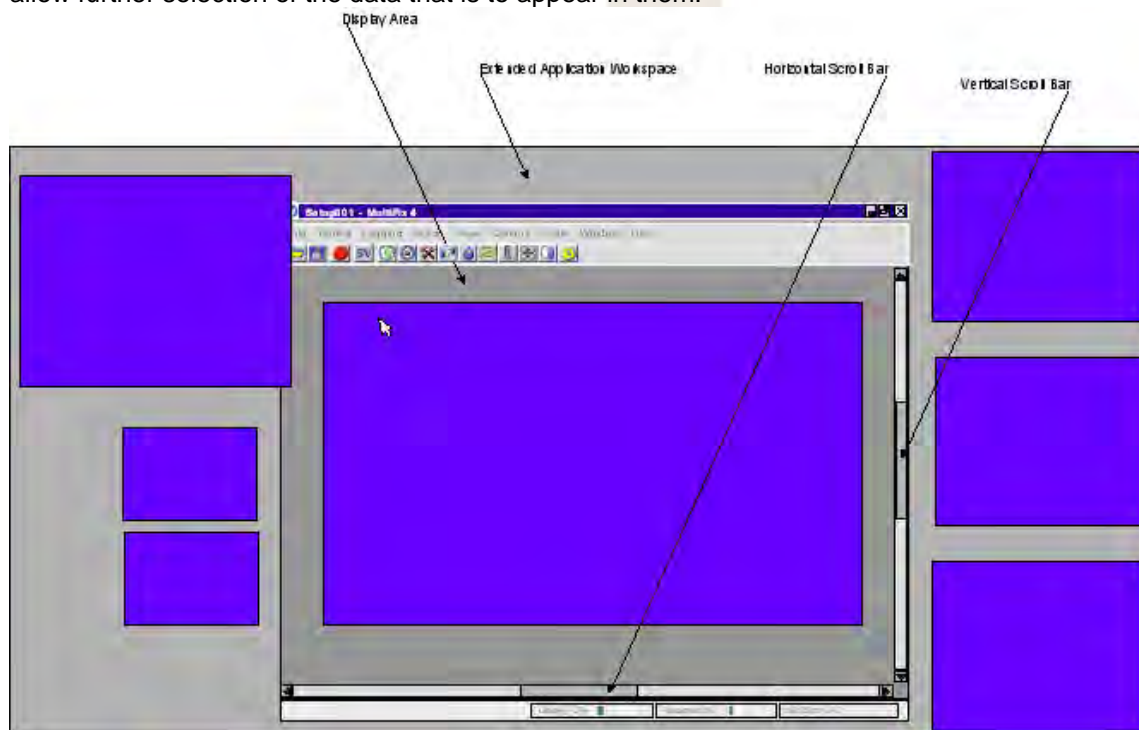

Most windows can be resized by clicking and dragging the corners or sides. Some windows that contain text will wrap the text message into the available space. Other windows containing text will simply be cropped as the window size reduces. Windows containing graphical information will resize down to a minimum and will then either crop the information or will introduce scroll bars.

#### 3.4.5.1. Files

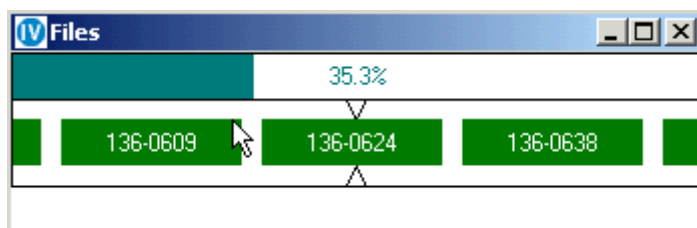

In replay mode the progress of the playback can be followed in the "Files" view window. The upper bar shows the status of the replay in percentage of the total time, while the lower part of the window shows the selected files as green blocks and the progress within the current file.

#### 3.4.5.2. Work Area

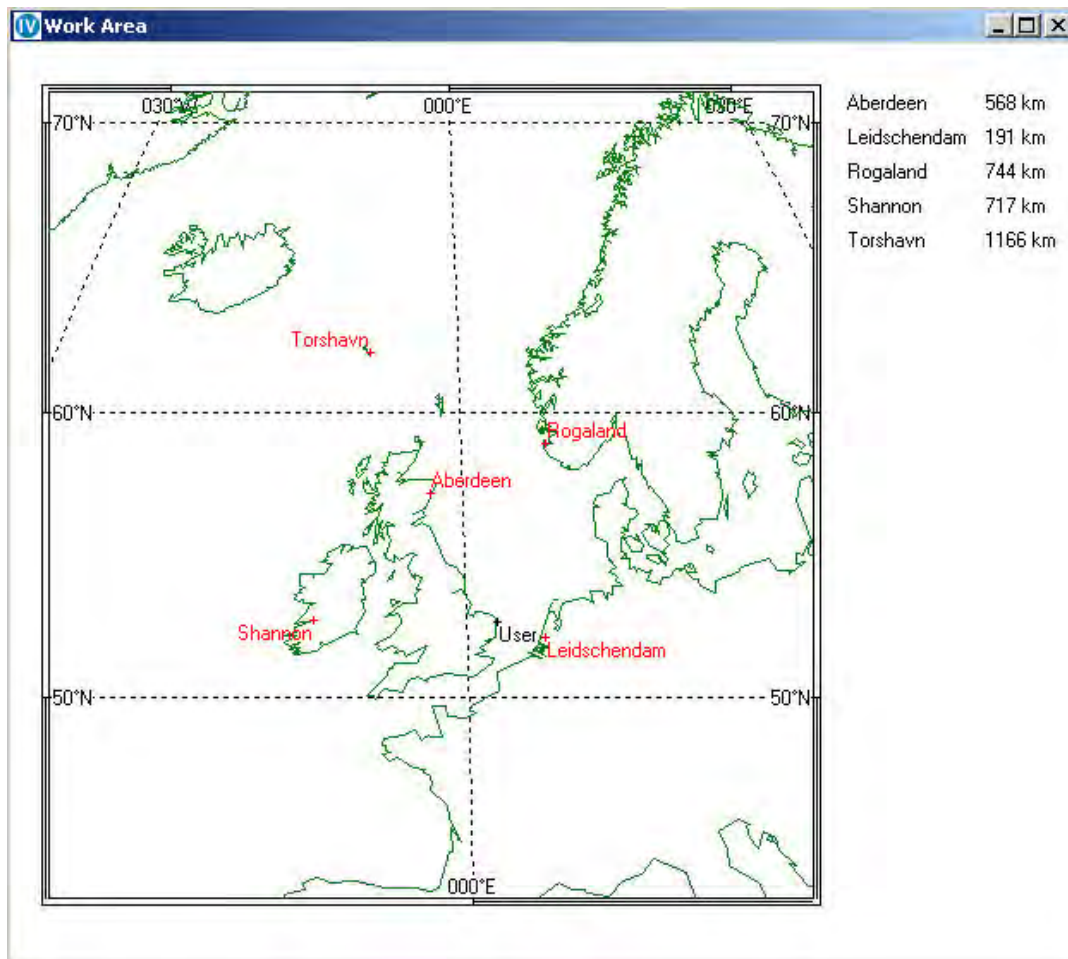

This calls up a diagrammatic map, which will encompass the user's current position and the positions of all reference stations currently selected, and available, in the **RTCM** input data.

The right hand side of the window contains the ranges to each of the selected stations, based on the users current location.

This window has a "Copy" and "Save As..." facility, accessed via the right mouse button click.

The work area can also be called up by clicking .

### 3.4.5.3. Input/Output

There are three sub-menus and each will call a window to the MultiFix application workspace.

### 3.4.5.3.1.Status

This window indicates when there is port activity.

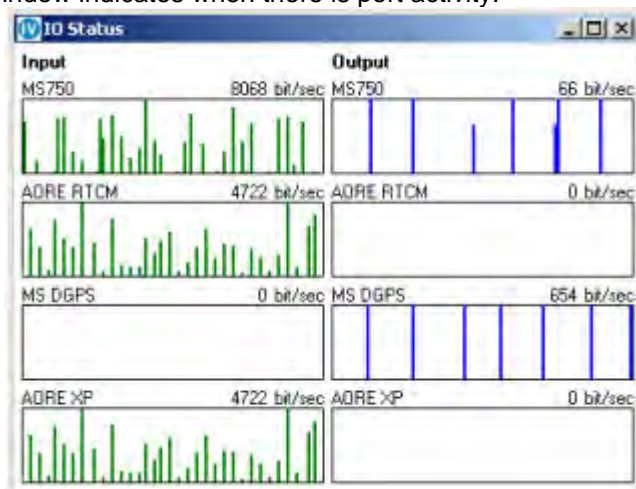

By default the window will contain the ports MultiFix knows to exist. The "None" I/O Channel is at the top followed by streamed socket channels, datagram sockets and then the COM and **Digiboard** channels.

(When setting up Input / Output channels there is the option to select a dummy channel "None". If selected the blue vertical bars would be seen progressing across the None Output box).

A right-mouse click calls up the **Channel** button. When this is clicked the IO Status dialogue is presented.

This allows channels to be selected or deselected from the status window.

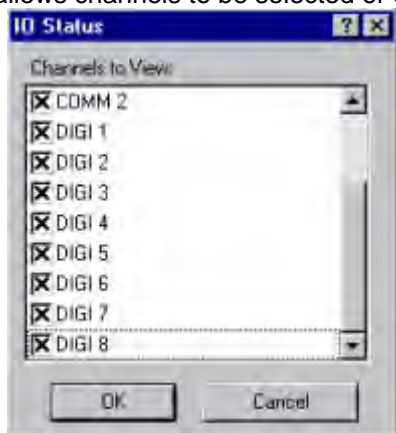

In the IO Status window the latest time is in the centre between the Input and Output columns. Each box indicates when data has been input or output, over the last 5 seconds, on that port by scrolling vertical bars from the centre to the outside edges of the window. The box re-scales such that the greatest data rate over the last 5 seconds is full scale. The current bit rate is shown opposite the I/O channel name.

### 3.4.5.3.2.Sockets



A client socket can have three states,  
**Idle, Connecting** and **Connected**.

Idle and Connecting will alternate while connection is trying to be established. There will also be a time countdown to the next attempt to make contact.

A server socket can have two states,  
**Idle** and **Listening**.

The Idle status is almost immediately replaced by Listening.

#### 3.4.5.3.3.Datagrams

The screenshot shows a window titled "Datagram Status" containing a table with the following data:

Socket	Port	IP Address	Packets In	Packets Out
Datagram - active	5003	10.1.2.19	3	0
Broadcast - active	5004	Broadcast	0	0

The Datagram Status window lists all Datagrams in use. The IP address indicates to which PC a link is in place or if it is transmitting a broadcast message. The "Packets In" and "Packets Out" window indicates if the datagram is working. If you are receiving data only the "Packets In" will increase. If you are transmitting to n PCs the "Packets In" will increase at n times the rate of the "Packets Out".

#### 3.4.5.3.4.Scroller

Scroller is able to display any of the inputs and outputs. When first opened the display defaults to showing the link to/from the **GPS** receiver. To change to another IO Channel or to change the scrolling options, click the right mouse button.



This calls up a menu box, which has “Device”, “Freeze”, “Clear” and “Show” as shown below.



If “Device” is highlighted there is a sub-menu which lists the different input / outputs. Top of the list is the name given to the GPS receiver. This is followed by the **RTCM** source(s) and then by the output(s).

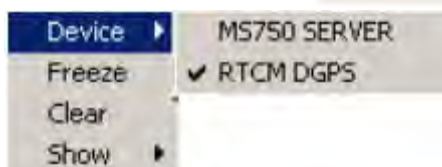

If “Freeze” is selected the current window display is held and frozen appears in the windows title bar. Clicking “Freeze” again unfreezes the display. “Clear” will remove all information from the current window.

“Show” brings up a new sub-menu with four options: “Input”, “Output”, “Text” and “Corrupt”. A tick next to the option indicates that the relevant information is currently displayed in the Scroller window. These options may be toggled on or off by left clicking.

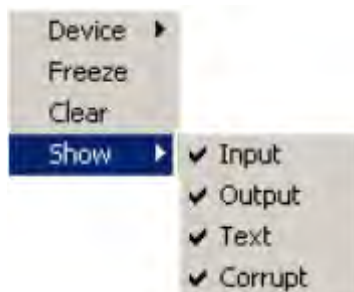

The text in the window is bottom justified and colour coded. Green indicates it has been successfully decoded and passed all parity checks, red indicates the data is corrupted and dark blue is reserved for the outputs: [GPS Receiver](#), [RTCM Input](#) and [Output Strings](#). When a message is received or sent successfully a black text line is added as a label. Carriage return and line feed are shown in light grey.

Scroller windows use a lot of resources and should be closed when they are not required.



For inputs it is usual to turn off the "Input" (green) section.

### 3.4.5.3.5.GPS Receiver



```

750 - Scrolling IO
u/As.a...|buG|.....@Usj@...An.A_@...|.....@F|...Avn4A<A<3...L.4el.....@<...A4
URP...z0.....@9.u.<cr><lf>
In : Raw Data 166 (1 of 3)
.W.#.f...Axp.B.$|Af...@...B.".....6@GY|...Av|H|-|Ac^u|'...[(83...@A&f...A^.....>...
r.....@||...A|0.0.#Aqk|0. @. u.....@DL...Ak1q...|.....@E...Aw?..uA|...@R...34|...
@=|...AUr.|' <cr><lf>
In : Raw Data 166 (2 of 3)
.W.3...z0j+...W.<cr><lf>
In : Raw Data 166 (3 of 3)
.W^...?0.$..?)Y|RR%@Q^C|#6x@.sP.?..@z.90z{.@.&...%W(8cL%4.8Pp.bz...^'...>J.|.....3
<cr><lf>
In : Raw Data 166 (1 of 1)
|CH SV EL/AZ CODE SNR/L2 IOD URA 1 28 22/273 C/E 43/30 160 2.8 2 11 87/1
63 C/E 52/47 89 2 3 31 24/166 C/E 45/29 145 2j0.<cr><lf>
In : 82 161
.T...T.<cr><lf>
Out : Request Ephemeris 07
U.....E.....%.....=E....?T....@F|...>.E{R^j&t.@.>@SU|I|?|Us@...>T.vYQI@.l.E.>
sj|RS.?K@E.%_0m...?0%b6E..@q.....z&Y|K@.%'z|.l=...inT.....<cr><lf>
In : Ephemeris 07
|CH SV EL/AZ CODE SNR/L2 IOD URA 1 28 22/273 C/E 43/30 160 2.8 2 11 87/1
63 C/E 52/47 89 2 3 31 24/166 C/E 45/29 145 2j0.<cr><lf>
In : 82 161
.W...A|t...?|...u.r.....@D...Avj...@-0A|-E.....B.....@>E...AU(wA...wX@.....W.@.f...
AsS$|As.r0.|R.z|.....@G|...An.b7E...aM'.....@F.f...Avnib#pA<'l...

```

### 3.4.5.3.6.RTCM Input

```

Europe SPOT - Scrolling IO
Y"A,WZU"HP.gv @hITE.IJFF]IUCiBxfV@~na IUpzHswUKBwoP_Liux(KP@dHte@U96U 1: 1
2 5 0 7:12.0
IAVDMZw)DhJKEH@RNNQ.p(XE@~DuvIwHhDBTUS.kEX.N@SZB.wDGL_bp0700 1: 10 1 0
7:13.2
Yzkip/Aw~qw|HbbDapTr_X|AGKyAmF0700 32: 4 1 0 7:01.2
IAy|]hedBYp|Ky).Wzq(@_r.TE.robg~FvG@|ui.YwGz@wy.NAC)oNMCY0750 1: 10 2 0 7:13.2
Y~qZHe dB^hlo|@lqK(|@Qu..e|FH.P|gxmDBdaX.kEpB_|LPmt|@PN_|bb0830 1: 10 2 0 7:12.0
Y~l_RhEnB|dK|U@rC\..mB^qe)H^CLA^VBh|ghC@PNN|@U.v.wz_@PulloY0705 1: 10 7 0 7:12.0
IAV.RhEIBBd_L_B@rDty@Rw_he)H^k)_Qh|gxD@PNN|@yI.fz_@PPH@PbM0703 1: 10 3 0 7:12.
0
IAvT|HEnDo|@Ljn.MIKc@b~_ZZBw_YGCV|h|eF@PN~r|@l(hv)..m0714 1: 9 7 0 7:12.0
Y~IolHE|Bfd.M|w.MIKF.uD^ge)HP|w~_i|h|gP|oqgg@Mv.@E^_o|W|APbd0706 1: 10 5 0 7:12.0
Y~ID(W_|Yd.Cah.OIK.O_|@|@|ZBw_Y~|oV|U|h|G|Uf.oqgg@|~_kz_@PPE@Pba0707 1: 10 0 0 7:14
.4
Y~l.W|Q|Ad.)Cw.O|Kj@R|.le)H^CD|oV|e|W|C_X..m.oqgg@Cl.fz_@PPS@Pb 0704 1: 10 7 0 7:14.4
Y~I{zW|juxuo@HQ|@h|NB.E.s.ke^MPQWB@yoG@DZm.|w.y0712 1: 7 5 0 7:14.4
Y~IwqW|)Fd.spz.O|Kj@by.fe)H^r|A|H|h|G|bi.oqgg@Gu.mz_@PPBCPb0708 1: 10 4 0 7:14.4
Y~q|W|W~no@HYD@h|Y.q|@u|H^a|@P|y|G@D~.|wqZ.DM@qzoAHcC|.pLD.aDY@oH@M077
7 1: 12 1 0 7:14.4
IAvh|W|j_xvo@Hvq|Wvc|@JD@le^MPQGB@y|G@d|X@dH@F0709 1: 7 0 0 7:14.4
IAv(W_|Yd.|H..O|Kj@bw_|ZBw_Ya)oV|H|G|R@PNNX.u|@DE^_o|h|BPb.0715 1: 10 0 0 7:14.4
Y~I_zW|Y|x|@DZL@pD|U.mE@MZBw_|y@P|K|W|C_X_@PNNX.zB@bz_@pbd|o|k|0702 1: 10 6 0 7
:14.4
Y~I|mW|_|L_@E|_q|MNX_GD^az.BPm~YYAp)GFd@Vz|b@KK@MGcrODg.Oy^0720 1: 10 0 0 7:1
4.4

```

### 3.4.5.3.7. Output Strings

```

DGPS OUT - Scrolling IO
$GPGGA,1.50728,5236.170659,N,00117.075518,E,2.05,1.3,29.64,M,45.60,M,0.0,1.001*5U<cr><lf>
DGPS OUT Output 91
$GPGGA,1.50729,5236.170651,N,00117.075552,E,2.05,1.3,29.59,M,45.60,M,6.0,1001*57<cr><lf>
DGPS OUT Output 92
$GPGGA,1.50730,5236.170660,N,00117.075569,E,2.05,1.3,29.61,M,45.60,M,7.0,1001*5F<cr><lf>
DGPS OUT Output 93
$GPGGA,1.50731,5236.170664,N,00117.075589,E,2.05,1.3,29.79,M,45.60,M,8.0,1001*52<cr><lf>
DGPS OUT Output 94
$GPGGA,1.50732,5236.170653,N,00117.075557,E,2.05,1.3,29.87,M,45.60,M,4.2,1001*59<cr><lf>
DGPS OUT Output 95
$GPGGA,1.50733,5236.170684,N,00117.075571,E,2.05,1.3,29.95,M,45.60,M,5.2,1001*54<cr><lf>
DGPS OUT Output 96
$GPGGA,1.50734,5236.170694,N,00117.075570,E,2.05,1.3,29.94,M,45.60,M,5.0,1001*50<cr><lf>
DGPS OUT Output 97
$GPGGA,1.50735,5236.170705,N,00117.075575,E,2.05,1.3,29.78,M,45.60,M,6.0,1001*5C<cr><lf>
DGPS OUT Output 98
$GPGGA,1.50736,5236.170699,N,00117.075594,E,2.05,1.3,29.78,M,45.60,M,7.0,1001*55<cr><lf>
DGPS OUT Output 99
$GPGGA,1.50737,5236.170695,N,00117.075582,E,2.05,1.3,29.80,M,45.60,M,8.0,1001*57<cr><lf>
DGPS OUT Output 100
$GPGGA,1.50738,5236.170730,N,00117.075545,E,2.05,1.3,29.81,M,45.60,M,9.0,1001*5D<cr><lf>
DGPS OUT Output 1
$GPGGA,1.50739,5236.170776,N,00117.075511,E,2.05,1.3,29.90,M,45.60,M,10.0,1001*67<cr><lf>
DGPS OUT Output 2
$GPGGA,1.50740,5236.170772,N,00117.075463,E,2.05,1.3,29.80,M,45.60,M,3.8,1001*52<cr><lf>

```

### 3.4.5.4. GPS

#### 3.4.5.4.1.Receiver

This menu item will only appear if a 4000 (Trimble), 5700 (Trimble), **BD750** (Trimble), MS750 (Trimble) or DSM232 (Trimble) **GPS** receiver has been defined. This window cannot be resized.

Assuming communication has been achieved between the receiver and the MultiFix program, the [Yellow Box](#) window acts as a remote interface with the GPS receiver in use. Clicking a button in the window performs that action on the receiver. Likewise if the menu on the receiver is being used the “Yellow Box” receiver window in MultiFix will update to the currently displayed page.



The **UTC** time displayed in the “Yellow Box” window will always be 1 or 2 seconds behind the UTC time shown in the Clock window. This is not a cause for concern as it is due to the time taken for the receiver to provide the front panel text.

Beware: Do not change the settings of the port communicating with the MultiFix program. Once communication is lost it cannot be re-established from MultiFix and must be done via the receiver.

#### 3.4.5.4.2.SNR

The display shows the signal to noise (**SNR**) levels of each of the tracked satellites as a button on a bar. The width of each bar shows the minimum and maximum over the last 60 updates. The button position shows the current value. The button will be Red when there are <30 values in the filter, Yellow when between 30 and 59 and Green when 60 values have been obtained.

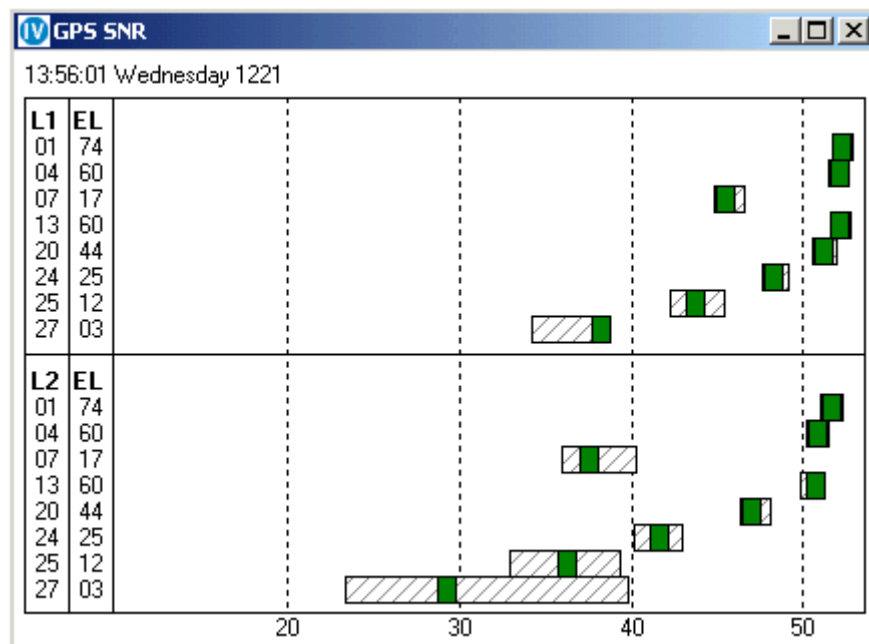

If two Measurement windows are opened they will not show the same information until the second Measurement window has received 60 updates.

The signal level may vary widely if the satellite is just rising, setting, or if high levels of *Multipath* are present.

The X-axis re-scales as a function of the least minimum and the greatest maximum to be displayed.

The Y-axis will re-scale as rising satellites are acquired and setting satellites are lost.

Satellites for which there is data from the **GPS** receiver will still appear in the window even if they are disabled in "Action" \ "SV Status".

If using a dual frequency receiver then SNR's will be shown for **L1** and **L2** when in L1/L2 or XP mode.

The "EL" column shows the elevation angles of the tracked satellites. By right clicking and selecting the  Sort By Elevation option satellites can be sorted by elevation angle. Unselecting this option will rearrange SNR's in ascending PRN order.

#### 3.4.5.4.3. Scintillation Meter

The "Scintillation Meter" window provides a visual display of how the scintillation filter is working.

For an explanation of scintillation see [APPENDIX B – Understanding Scintillation](#).

The display contains four bars for each satellite currently being tracked.



The four bars are subdivided into two representing each frequency. The upper pair shows tracking on **L1** and the lower pair shows **L2**.

The upper of each pair of bars represents the number of interruptions detected during the past 60 seconds. If there are no interruptions the bar remains empty.

The lower bar indicates the time since the last detected interruption.

The full length of this bar equates to 60 seconds.

The vertical black line across the whole display indicates the threshold for the maximum number of acceptable breaks during the past 60 seconds. This is set to two.

When data is acceptable the display remains green.

When the scintillation filter rejects data the display will turn red. If no data is currently available then the display will turn grey.

**Please note** that if data is rejected on L2 only data will remain available on L1 for single frequency calculations.



### 3.4.5.4.4.Code Carrier (CCF)

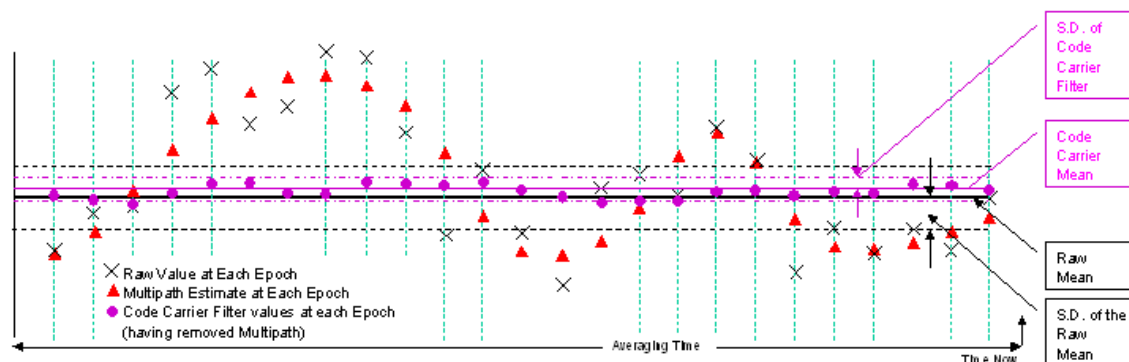

At the heart of the *DGPS* and Premier calculations is the Code Carrier Filter. This filter attempts to model and remove *Multipath*. Strong Multipath has a regular short-term cyclical pattern whereas noise is considered to be random, therefore for each epoch the program estimates what effect Multipath is having on the measurements from each satellite. It then derives measurement values with the estimated Multipath removed.

The heart of *SkyFix XP* calculations is a Kalman Filter.

The Code Carrier Filter performance is displayed in the following two windows, "Summary" and "Time Series".

#### 3.4.5.4.4.1.Summary

The code carrier filter displays are arguably the most significant displays for monitoring *GPS* measurement quality.

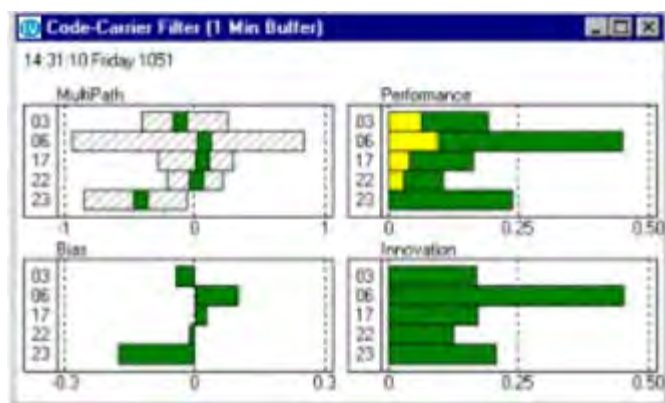

The right-mouse button provides display options for the window.

Any of the four bar chart information panels can be turned off or on by checking or un-checking the relevant name.



The averaging time used for the display can be set to 1 minute, 2 minutes or 5 minutes. (This does not change the Time Constant of the Filter itself). The averaging time is a moving window, losing the oldest adding the newest.

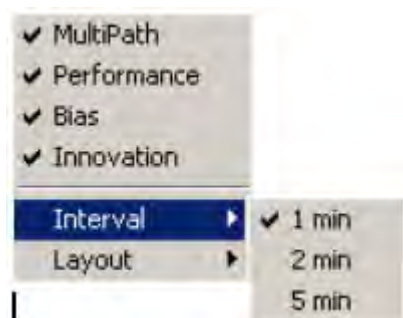

The layout can be set to Square (as shown above), Column or Row.

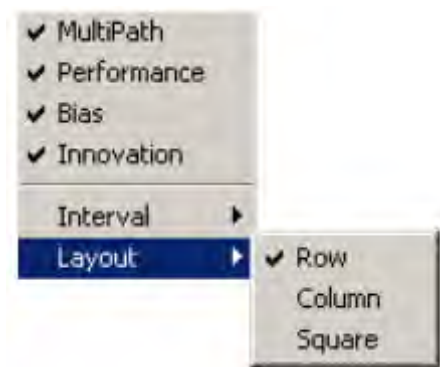

The yellow bars represent the standard deviation of the code carrier filters values and the green bars represent the standard deviation of the raw code carrier values.

All the panels re-scale as a function of the range of values to be displayed.

- Take particular note of the axis labels.
- All units are in metres.

**“MultiPath”** shows the results of the program's modelling of the Multipath. Each Multipath panel button shows the current Multipath estimate. The hatched area shows the minimum, maximum range of the Multipath over the averaging time being used for the display. If the filter is working satisfactorily the buttons should oscillate either side of 0 in a random manner. If the values persist in fluctuating more than 2-5 metres, or some of the current values stay high, it may indicate the antenna is sited in an area prone to Multipath and removal to another location may be advisable.

**“Performance”** shows the Standard Deviation of the Code Carrier Filter values and the Standard Deviation of the Raw Code Carrier values.

**“Bias”** shows the difference between the mean of the Filtered Code Carrier values and the mean of the Raw Code Carrier values. If the filter is working perfectly the mean of the filtered values should be the same as the mean of the raw values and therefore should be 0. A large difference indicates the filter is not modelling the raw data successfully.

**Innovation** shows the Standard Deviation of the Innovation. Innovation is the difference between the Code Carrier Filter's predicted value and the Code Carrier Filter's raw value (corrected for Multipath). If the filter is performing successfully the raw values should be randomly distributed around the filtered prediction. The movement should be due to receiver measurement noise and is an indication of the quality of the GPS measurements.

#### 3.4.5.4.4.2. Time Series

This is a time series representation of the code carrier filter for each measurement over the last 5 minutes.





The right-mouse button provides display options for the window.



“**Raw**” - shows red dots representing the raw observations

“**Filter**” - shows a smoothed green line indicating the observations after the **Multipath** estimate has been removed

“**Multipath**” - shows an erratic yellow line is the Multipath estimate.

“**Natural**” - a smooth blue line is going to be removed.

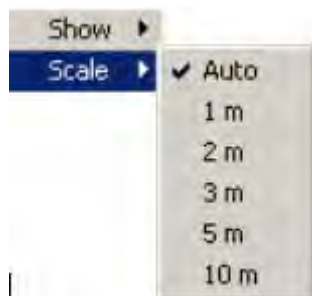

If dual frequency data is being received two sets of graphs will be displayed, showing the code carrier filter information of both the **L1** and **L2** frequencies.

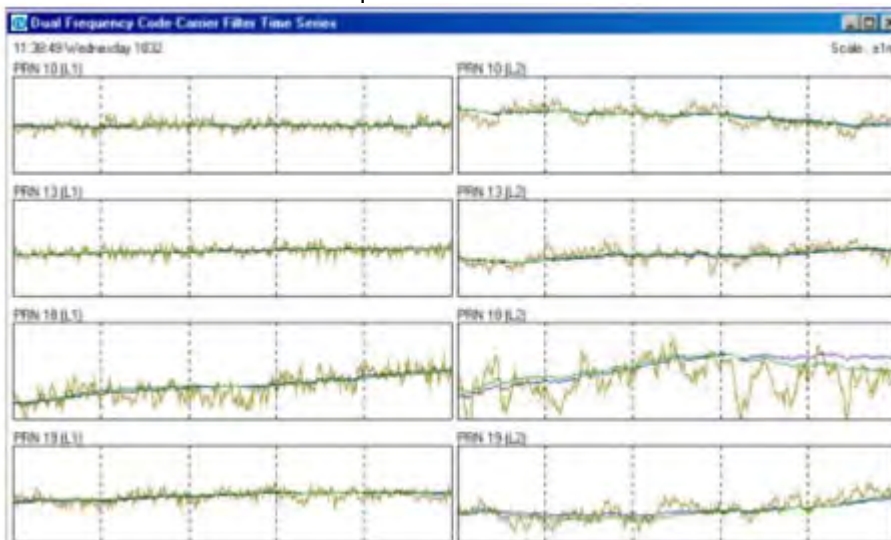

#### 3.4.5.4.4.3.SNR Weight

This screen provides information with regard to the signal to noise ratio weightings of the measurements. Generally, a lower **SNR** value is indicative of more noise and **Multipath** in an observation. MultiFix will give more weight within the computation process to a measurement with a higher SNR value.

Measurement ID	PRN	Code	Carrier	Phase	SNR	Weight
1	3	-0.86	0.90	1.79	2.62	
1	14	-2.05	-0.03	1.44	3.05	
2	45	-2.62	0.07	1.18	2.69	
3	254	-5.55	0.01	1.16	3.01	
4	559	-4.86	0.00	1.11	3.52	
5	902	-2.86	0.01	0.94	2.87	
6	1251	-3.17	0.01	0.90	3.93	5.48
7	3445	-3.52	0.01	0.81	2.94	4.89
8	9518	-2.79	0.01	0.68	4.05	4.11
9	4020	-2.22	0.00	0.63	2.29	3.80
10	11745	-2.71	0.00	0.59	2.22	3.58
11	17707	-2.54	0.00	0.52	4.14	3.18
12	17595	-2.26	0.00	0.49	1.99	2.90
13	17674	-1.94	0.00	0.43	2.23	2.63
14	11751	-2.07	0.00	0.40	1.85	2.42
15	19527	-2.07	0.00	0.35	1.74	2.10
16	16980	-1.67	0.00	0.32	2.18	1.93
17	13483	-1.24	0.00	0.28	1.34	1.72
18	12135	-1.29	0.00	0.26	1.34	1.56
19	12626	-1.05	0.00	0.23	1.35	1.43
20	16418	-1.01	0.00	0.20	1.04	1.21
21	19094	-0.94	0.00	0.19	0.92	1.14
22	11876	-0.86	-0.01	0.17	0.77	1.03
23	827	-0.43	0.00	0.16	0.50	1.00
24	103	-0.36	0.03	0.18	0.40	

The first column shows the SNR value of the measurement.

The second shows the number of observations with that SNR value.

The third is the minimum measurement.

The fourth column is the mean.

The fifth column is the standard deviation of the observations.

The sixth column shows the maximum value.

The final column shows the relative weight of the measurements with respect to the best value, which is assigned a value of 1.00. If there are less than 600 observations for an SNR value the program will use the next lowest SNR value with more than 600 observations. If no SNR values have more than 600 observations it will use the default setting.

#### 3.4.5.4.5.Iono Filter

The options available from the “Iono Filter” menu will only be available if MultiFix is receiving dual frequency data from a **GPS** receiver using the **CCF** filter in a “Premier” calculation. Values of the ionospheric delay are derived from this filter. There are two options available from this menu that are the same as those available in the Code Carrier Filter menu as the same form of data is used in both filters, i.e. Time series and Summary. The data can be treated in the same way and therefore the same filters can be used.

##### 3.4.5.4.5.1.Summary

Refer to [Summary](#)

##### 3.4.5.4.5.2.Time Series

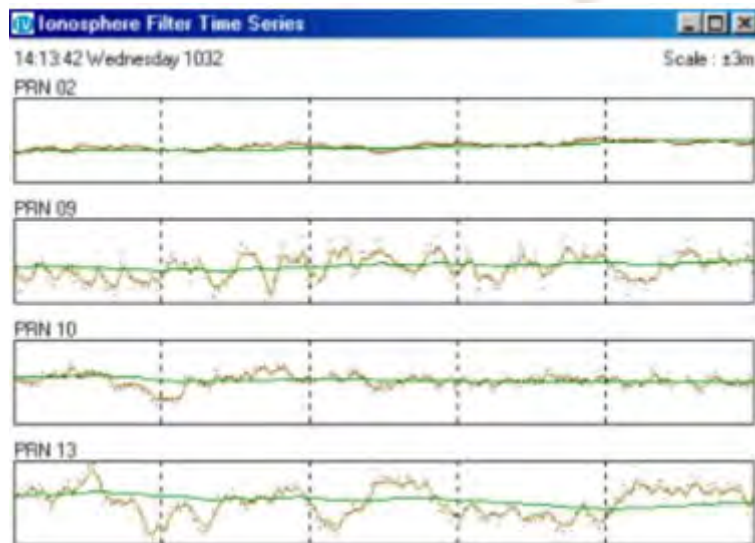

The time series plots for the Iono Filter will be noisier than the Code Carrier Filter plots because they are a combination of the *L1* and *L2* frequencies. [Refer also to Time Series.](#)

#### 3.4.5.4.6.Ephemeris

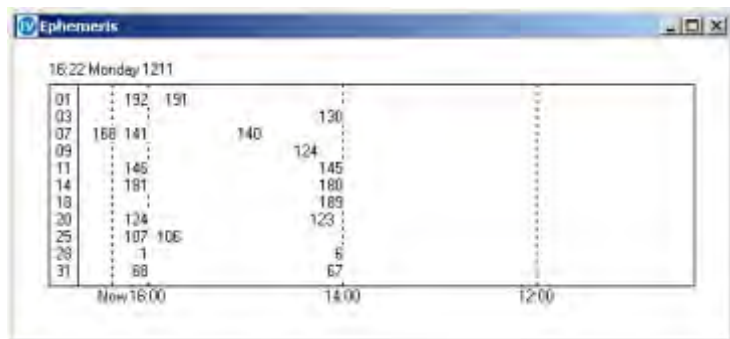

The Ephemeris window shows the previous 6-hour period. The Ephemeris issue number is placed at the time when an update was received. The issue number typically increments by 1 but that is not always the case. The majority of updates occur every 2 hours. Updates between this period may be due to a rising SV.

A right-mouse click on the window provides the "Copy" and "Save As..." facilities.

#### 3.4.5.4.7.Almanac

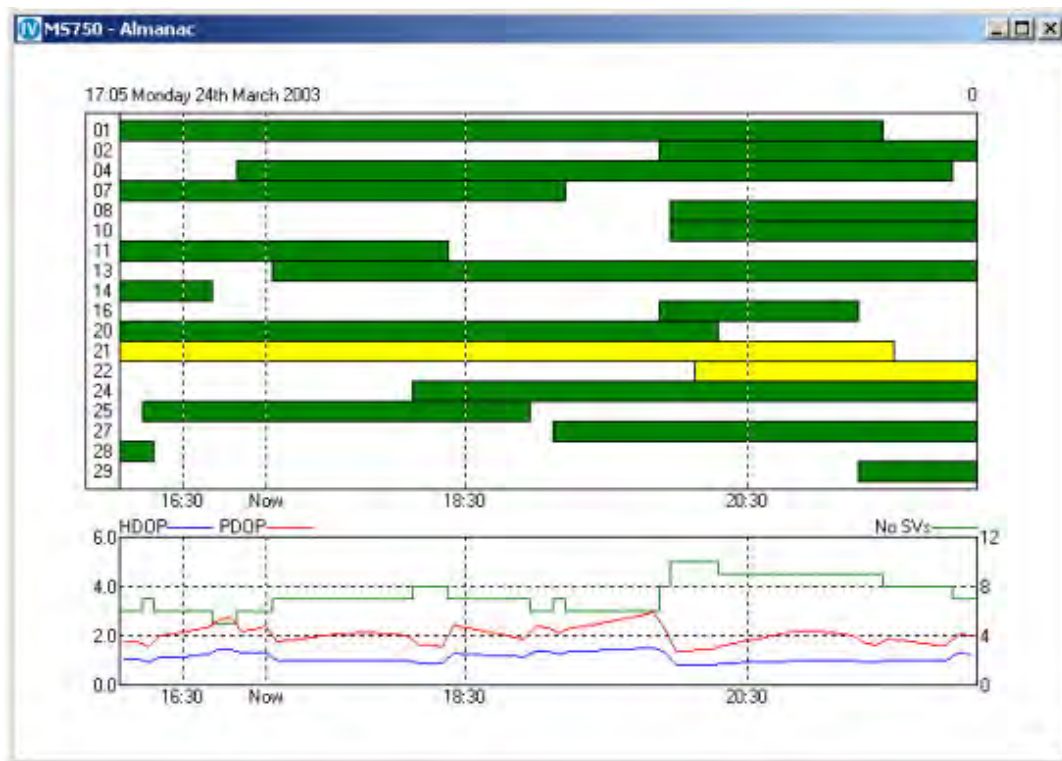

A right-mouse click on the window provides the “Copy” and “Save As...” facilities as various other options.



The **almanac** view can show the “Average Position”, which is the average of all the current calculations, or the “Trial Point”, (mostly used during times when the program is offline or for planning purposes). This does not affect the view when the top item in the menu is selected, in this example MS750. This is the **GPS** receiver and when checked indicates the almanac is referring to the current average position. When one of the reference stations is selected extra information becomes available on the plot as shown below.

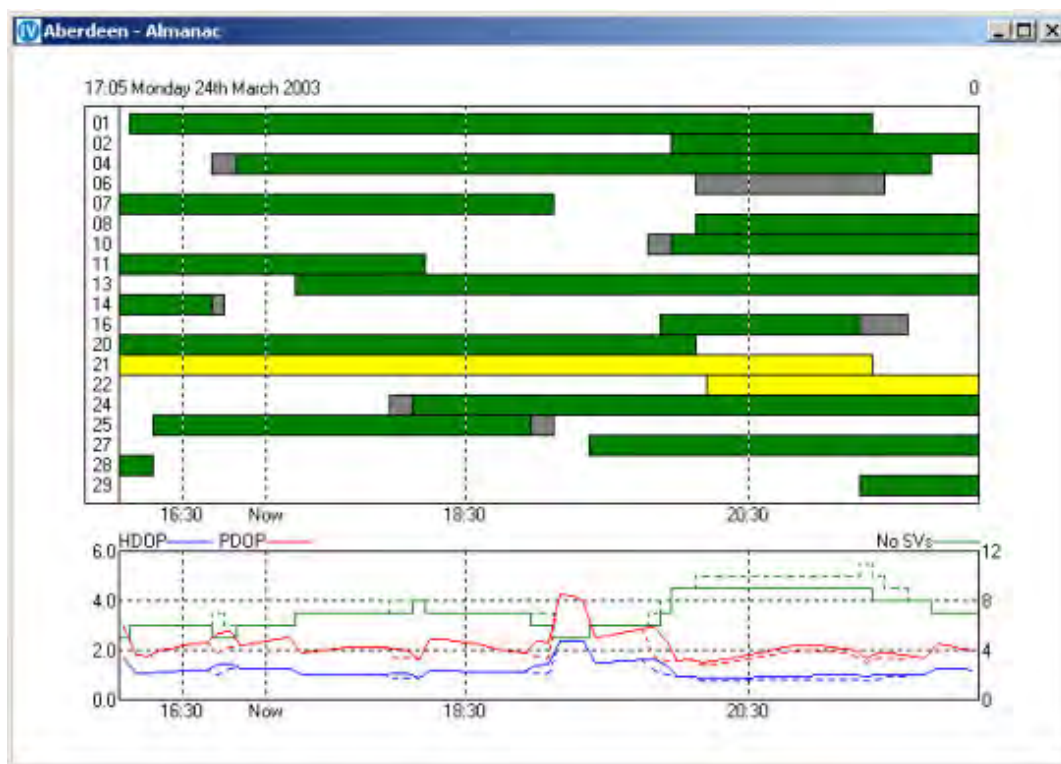

The top section of the Almanac window is a bar graph display of the availability of satellites over the previous 2 hours and the next 4 hours. This can be changed to a 24 hour view using the right click menu. The 24 hour view shows the current day, from midnight to midnight **UTC**.

- The green bars represent healthy satellites above the elevation mask.
- If an SV is disabled in the “Action” \ “SV Status” dialogue than the bar for that SV will appear red.
- The grey areas indicate the SV is above the 10° elevation mask at the reference station but not at the “average position” or the “trial point”. (Note that the minimum elevation mask is set in the “Config” \ “Calc” \ “Settings” dialogue, (see Section 4.3.3.4.1 on Page 60). By default this is 10° but can be changed resulting in the SV availability shown in the Almanac window altering.)
- The yellow bars represent unhealthy SV’s.



The lower section shows the Number of SV's, **PDOP** and **HDOP** on a line graph over the time period specified.

- The number of satellites available for the selected position calculation is shown as a solid green line.
- The number of satellites visible at both the reference station(s) and the selected position is a green dashed line (where applicable).
- PDOP at the selected position as a red dashed line.
- PDOP based on the common satellites above the masks as a red solid line
- HDOP at the selected position is shown as a blue dashed line
- HDOP based on the common satellites above the masks as a blue solid line

If "Network" is selected the Almanac window is based on the current "average position" or the "trial point" and will show a green availability bar if there is at least one of the reference stations that has a common satellite. If the bar is grey then the satellite is available at the "Average" position or "Trial Point" position but not at any of the reference stations.

It is worth noting that MultiFix uses "Elevation Delta" for rising and setting satellites. "Elevation Delta" is a variable weighting of the satellite data in the position solution. The minimum elevation when a satellite starts to be used and the number of degrees above the minimum at which the satellite attains full weighting are set in the "Config" \ "Calc" \ "Settings" dialogue referred to above.

#### 3.4.5.4.8.Clock

As can be seen, **GPS** Time was 13 seconds ahead of **UTC** Time when this screen dump was taken.



It is possible to include extra clocks in this display by right clicking in the window and selecting "Add Local...".

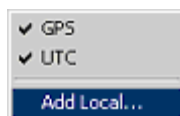

Enter a name for the clock and the time offset, in the format (hh:mm:ss), then click [OK].



These can be used to provide a local time offset from UTC for the work area.



Right clicking on the window now provides extra options to "Edit", "Delete", or "Hide" the additional clock(s).

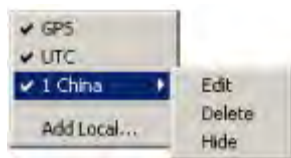

#### 3.4.5.4.9. Measurements

The Measurements window shows the current epochs GPS data received for each SV and each frequency.



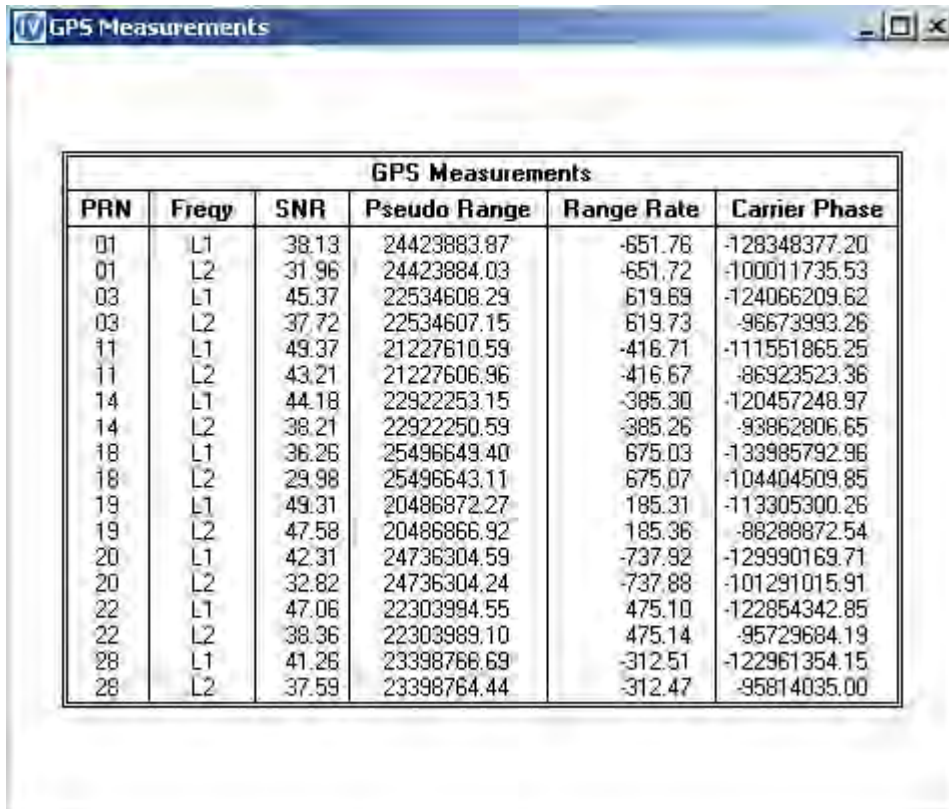

The screenshot shows a window titled "GPS Measurements" containing a table with the following data:

GPS Measurements					
PRN	Freqy	SNR	Pseudo Range	Range Rate	Carrier Phase
01	L1	38.13	24423883.87	-651.76	-128348377.20
01	L2	31.96	24423884.03	-651.72	-100011735.53
03	L1	45.37	22534608.29	619.69	-124066209.62
03	L2	37.72	22534607.15	619.73	-96673993.26
11	L1	49.37	21227610.59	-416.71	-111551865.25
11	L2	43.21	21227606.96	-416.67	-86923523.36
14	L1	44.18	22922253.15	-385.30	-120457248.97
14	L2	38.21	22922250.59	-385.26	-93862806.65
18	L1	36.26	25496649.40	675.03	-133985792.96
18	L2	29.98	25496643.11	675.07	-104404509.85
19	L1	49.31	20486872.27	185.31	-113305300.26
19	L2	47.58	20486866.92	185.36	-88288872.54
20	L1	42.31	24736304.59	-737.92	-129990169.71
20	L2	32.82	24736304.24	-737.88	-101291015.91
22	L1	47.06	22303994.55	475.10	-122854342.85
22	L2	38.36	22303989.10	475.14	-95729684.19
28	L1	41.26	23398766.69	-312.51	-122961354.15
28	L2	37.59	23398764.44	-312.47	-95814035.00

### 3.4.5.5. Corrections

#### 3.4.5.5.1.Orbit Data

This menu is available when **SkyFix XP** Mode is selected in "Config" \ "Calc" \ "Settings..."

##### 3.4.5.5.1.1.Time Series

This shows the received position and clock offsets for the selected satellites in four dimensions.

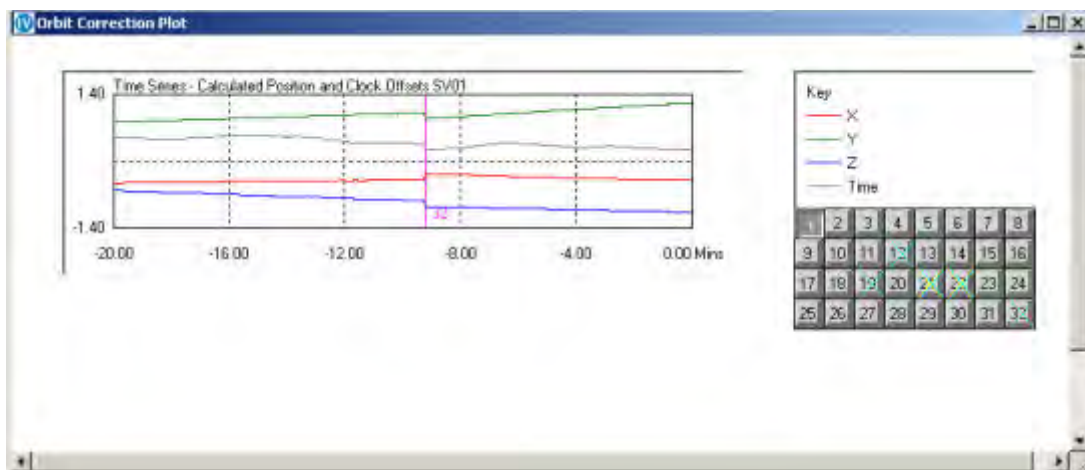

The red line is X, green is Y, blue is Z, and grey is Time.

To show the plot for a specific satellite, click the corresponding number on the number pad on the right hand side of the window. If more than one number is selected then the relevant graphs are added below the initial one.

Coloured crosses on the number pad indicate the status of the satellites as described below:

**Yellow** – The satellite is unhealthy. No plot is available.

**Light Blue (Aqua)** – The satellite data is missing

**Red** – The satellite had been disabled by the user via the “Action” \ “SV Status” dialogue.

The pink vertical line in the example above represents an **IODE** change with the values shifting after this event reflecting the new information received.

#### 3.4.5.5.1.2.Data Table

Current Source	Latency	Station ID	Last Update
1	9.147	811	16:34:04

PRN	IODE	Age	dX	dY	dZ	dX dot	dY dot	dZ dot	Clk
1	51	010	-0.031	-2.719	-1.297	0.00000	0.00000	0.00000	
2	1701	009	9.125	-9.695	-2.570	0.00012	0.00049	-0.00098	
3	2381	008	-0.688	0.570	1.148	0.00000	0.00000	0.00000	
4	2081	007	-2.320	-0.063	0.500	0.00000	0.00000	0.00000	0.063
5	770	006	0.523	-3.952	1.452	-0.00037	0.00012	-0.00073	-0.596
6	-11	000							
7	2241	004	-3.039	-0.273	1.313	0.00000	0.00000	0.00000	1.195
8	321	003	-1.406	-0.766	0.617	0.00049	-0.00024	0.00024	-0.196
9	1610	002	-1.344	-3.078	-4.406	0.00024	0.00037	-0.00037	0.836
10	1031	001	1.555	-1.602	0.117	-0.00049	0.00000	0.00024	1.773
11	2241	000	2.742	0.680	-0.523	0.00000	0.00000	0.00000	3.195
13	1021	027	1.344	-1.313	-2.305	0.00000	0.00000	0.00000	3.641
14	2310	026	1.125	1.734	2.047	0.00000	0.00000	0.00000	4.703
15	1761	025	3.672	1.859	1.281	0.00000	0.00000	0.00000	0.406
16	960	024	-0.367	3.125	1.109	0.00000	0.00000	0.00049	3.414
17	1451	023	3.688	3.414	-0.422	-0.00037	0.00000	-0.00061	2.813
18	010	022	0.789	1.305	-2.302	0.00024	-0.00049	-0.00024	
20	1761	021	1.133	-1.672	1.766	0.00000	0.00000	0.00000	
23	1431	019	3.383	-1.945	-8.992	0.00049	-0.00073	0.00012	
24	2140	018	-2.617	0.781	2.063	0.00000	0.00000	0.00000	
25	2120	017	1.359	-1.117	1.031	0.00000	0.00000	0.00000	
26	750	016	0.164	1.313	-1.164	0.00000	0.00000	0.00000	
27	270	015	0.406	-0.489	0.422	0.00000	0.00000	0.00000	
28	600	014	0.422	-2.414	-1.844	0.00000	0.00000	0.00000	
29	1971	013	0.851	-0.141	-0.750	0.00000	0.00000	0.00000	
30	1060	012	1.438	1.234	0.375	-0.00037	-0.00024	0.00012	
31	1731	011	-1.172	0.992	-0.805	0.00000	0.00000	0.00000	

The upper table of the “Orbit Correction Data” window shows:

“**Current Source**” – indicates whether System 0 or System 1 at the NCC is supplying the current **SkyFix XP** corrections.

“**Latency**” – Total elapsed time from the time of reference station measurement to when the user applies the correction (Calculation Time + Communication Delay).

“**Station ID**” - which is the Beam ID for the SkyFix XP corrections received.

“**Last Update**” - which is the **GPS** time of the last message received.

The lower table shows:

“**PRN**” - satellite number.

“**IODE**” - which is the Issue Of Data **Ephemeris** followed by a single bit IODE change flag (This toggles between 0 and 1 upon receipt of IODE).

“**Age**” - which is the elapsed time from the time corrections were last updated for a PRN.

“dX”, “dY”, and “dZ” - which are the current absolute orbit corrections, (the three absolute corrections per message give the position correction of the satellite in the three axes of Euclidean space, relative to the broadcast Ephemeris)

“dX dot”, “dY dot”, and “dZ dot” - which are the current orbit rate corrections (orbit rate corrections are used to predict the position of a given satellite during the period between its absolute orbit corrections).

“Cik” - which is the current clock correction (metre-level + sub-metre level corrections).

### 3.4.5.5.2.DGPS Data

#### 3.4.5.5.2.1.Station

Rome - Diff. Station															
Epoch		11:15:46 on 25th Mar 2003													
Message	Time	Latency	Percentage												
Type 1	11:15:37.2	8.8	82% #####												
Type 2	11:14:42.0	64.0	73% #####												
Iono	11:13:30.0	136.0	77% #####												
Message															
Location		11:14:21.0													
Time	11:14:21.0														
Latitude	41° 55' 37.584" N														
Longitude	012° 28' 11.909" E														
Height	96.10														
Distance	1454.56 km														
PRN	Position		Atmosphere			Type 1					Type 2			Direct	
	Elev.	Azi.	Direct	Iono.	Tropo.	Corr.	Rate	IODE	U	SF	Corr.	Rate	IODE	Delay	Rate
2	56°	273°	3.04	5.04	2.88	-10.42	0.000	190	0					2.94	0.00077
3	49°	304°	2.69	5.28	3.13	-10.12	0.002	182	0					2.84	-0.00109
6	04°	108°													
15	72°	025°	1.68	4.52	2.60	-8.22	-0.004	122	0					1.72	-0.00027
18	63°	216°	1.25	4.88	2.66	-8.68	0.004	66	0					1.19	0.00044
17	35°	061°	6.04	6.88	4.09	-9.60	0.000	91	0					5.54	-0.00367
18	54°	108°	0.76	5.47	2.94	-8.90	0.000	217	0	2.88	0.000	66		1.00	-0.00180
22	49°	298°													
23	51°	085°	4.24	5.59	3.05	-8.32	0.004	88	0					4.18	0.00047
26	04°	047°													
27	02°	327°													
29	01°	021°													
31	19°	297°	5.34	0.13	-7.17	-15.76	-0.008	116	0					5.64	-0.00217

The window initially opens showing the first **RTCM** reference station. To have the window show data for another station, right click on the window and select the station.

- The top left table shows the time tag of the latest messages, the age of the corrections and the percentage.

For Type 1 messages a percentage of 30 seconds.

For Type 2 messages a percentage of 300 seconds.

For Iono (Type 55 or Type 15) messages a percentage of 600 seconds.

Message (Type 16) a percentage of 600 seconds. When received the message will be displayed at the top of the window and will remain for 10 minutes unless overwritten.

- The Location shows the station position as received in the Type 3 message.
- The lower table has various sub-sections.
  - “PRN” is the satellite number.
  - “Position” shows the satellites’ positions and if they are rising the elevation is tagged with a ^.
  - “Atmosphere” has: -
    - “Direct” is the ionospheric delay derived for the present moment from the dual frequency information. (It will not be present if a single frequency reference station is selected).
    - “Iono” is the ionospheric delay for time now from the Klobachar model
    - Tropo is the tropospheric delay for time now from the tropospheric model.
- “Type 1” has: -
  - “Corrn.”, which is the current pseudo-range correction
  - “Rate”, which is the rate of change of the pseudo-range correction
  - “IODE”, which is the Issue of Data **Ephemeris**
  - “U”, which is the User Differential Range Error, (normally 0)
  - “SF” is flagged when the Correction Rate is greater then  $\pm 0.256$  or when the correction is  $> \pm 660$ .
- The “Type 2” table will usually only be seen during an Ephemeris change (every 2 hours), when the mobile’s **GPS** receiver is using a different Issue of Ephemeris to the reference station being viewed.
  - “Corrn”, which is the correction to the correction based on the difference in **IODE**.
  - “Rate”, which is the rate of change of the correction.
  - “IODE”, which is the Issue of Data Ephemeris number.
  - “Direct” contains the Ionospheric delay values and rates as transmitted in the Type 15 or 55 messages. (Without Type 15/55 information the section will be omitted).

#### 3.4.5.5.3.Performance

This window refers to a particular reference station.

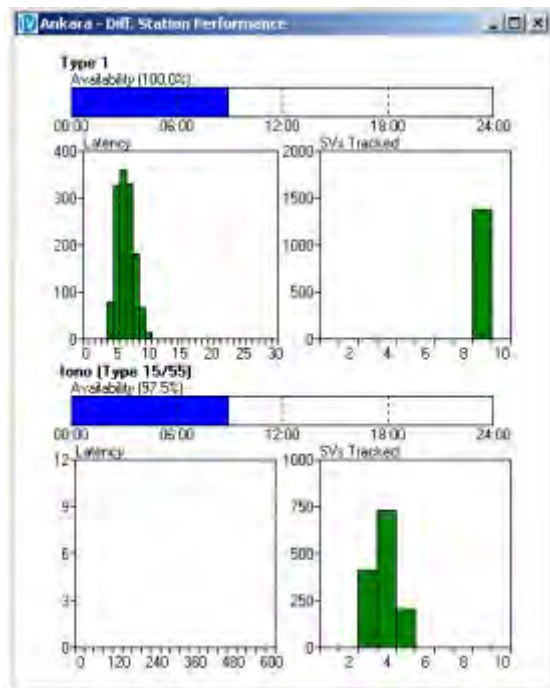

When first opened it defaults to the first reference station in the list. To change to another station use a right-mouse click and select a different station in the “Station” drop-down list.

A right-mouse click also shows that the view window can be copied and saved.

The **RTCM** Performance window has two sections.

- The top is for Type 1 RTCM correction messages.
- The bottom for Type 15/55 Ionospheric Delay correction messages.

If the reference station has not got the capability to transmit Type 15 or 55 messages then that part of the window remains blank.

The “Availability” bar at the top refers to the current day, midnight to midnight.

- A grey area indicates a period when the program was not running.
- A red area indicates when there had been no corrections received from the station for more than 50 seconds.
- A white area indicates either corrections were present or that time of day has not yet been reached.



The “Latency” histogram shows how old the corrections from the station were at each epoch, so if corrections that were 2 seconds old on receipt were received regularly every 6 seconds the histogram would show a spread from 2 to 8 seconds.

The “SV’s Tracked” histogram shows the spread in the numbers of SV’s tracked each epoch.

The “Iono Type 15/55” tables at the bottom show the same information as above for those message types.

The permitted Type 15/55 messages are not considered stale until 600 seconds has elapsed rather than the 50 seconds for the Type 1 messages.

### 3.4.5.5.3.1. Time Series

This window shows the pseudo-range differences between satellites computed positions for all selected reference stations. By clicking the mouse button on a satellite number in the key then the display changes to show only that satellite. The Y axis on the plot is metres.

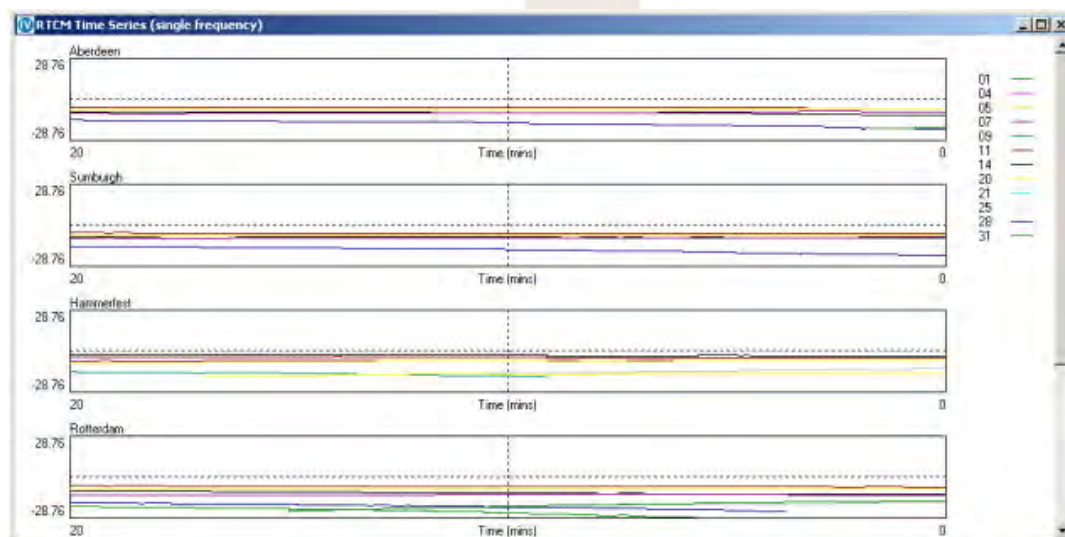

Right clicking on this window gives various options. Selecting a station in “Differences” will then difference all data to that station. This indicates how closely the positions for each satellite match at the selected reference stations.



Selecting “Scale” will give the option to change the Y-Axis automatically or show it at 1, 5, 10, 20, or 30 metres.

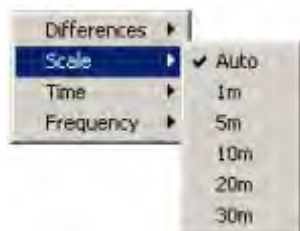

Selecting “Time” will rescale the X-axis to show 5, 10 or 20 mins.

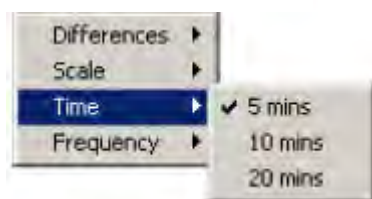

Selecting “Frequency” \ “Dual” allows dual frequency data to be shown for reference stations set up as an L1/L2 calculation.

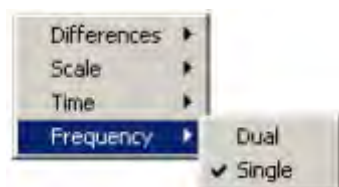

#### 3.4.5.5.4.Starfix Decoder

Assuming the [Starfix Decoder option](#) has been enabled and given an IO channel, the output from the decoder can be viewed.

The decoder can output “TEST” data on port 4 only. The interval between updates occurs every 1000 data blocks received and is proportional to the satellite channel data rate.

This update rate may be between 2.5 and 6 minutes.

##### 3.4.5.5.4.1.Table





ADRE RTCM		
Time		09:39:28
BER	Max.	5
	Ave.	5
	Min.	5
Voltage	Max.	3.1
	Ave.	3.0
	Min.	2.9
Freq. Offset		0.47

The table display presents the last data set received.

The **BER** or Bit Error Rate is typically between 5 and 7.

The Voltage is the signal strength voltage, <1 volt indicates poor signal level and >2 volts indicates good signal level. A large difference between min mean and max would indicate inconsistent tracking or interference.

The Frequency Offset should be in the range  $\pm 2.50$  kHz.

#### 3.4.5.5.4.2. History

The history display presents a time series plot for the current 24 hour period. Each point represents a summary for the past 1000 data blocks i.e. each message received. Note that the plot will reset at midnight **UTC**.

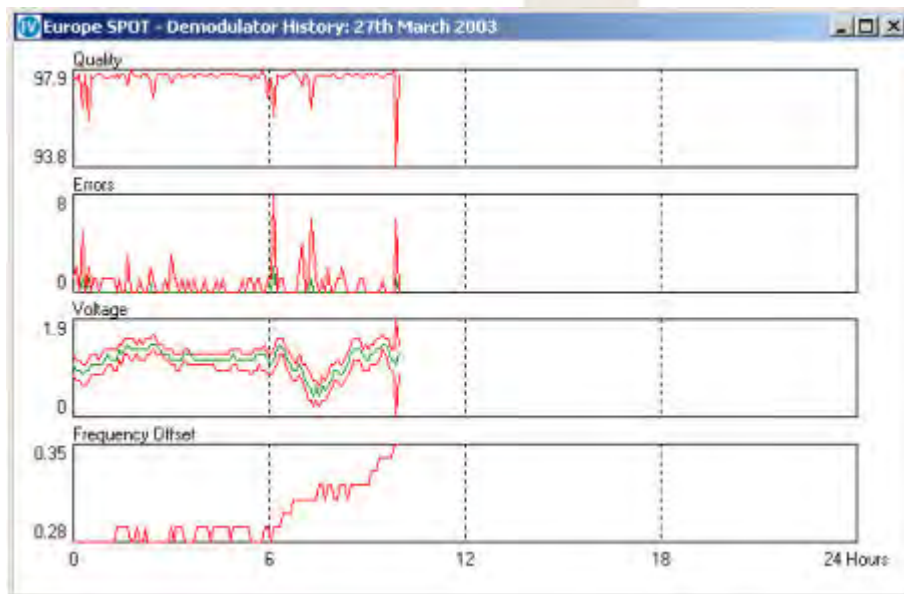

The plots displayed are as follows:

- **Quality** - The percentage of error free messages received
- **Errors** - There are two lines on this graph, the green relates block synchronisation losses and the red relates to the number of encoded block errors.
- **Voltage** - There are three lines, minimum and maximum (both red), and mean (green)
- **Frequency Offset** - The tuning frequency offset for the demodulator.

#### 3.4.5.5.4.3.Constellation

The **Constellation** window shows the position of the satellites as seen at the **GPS** receiver and at each of the reference stations.

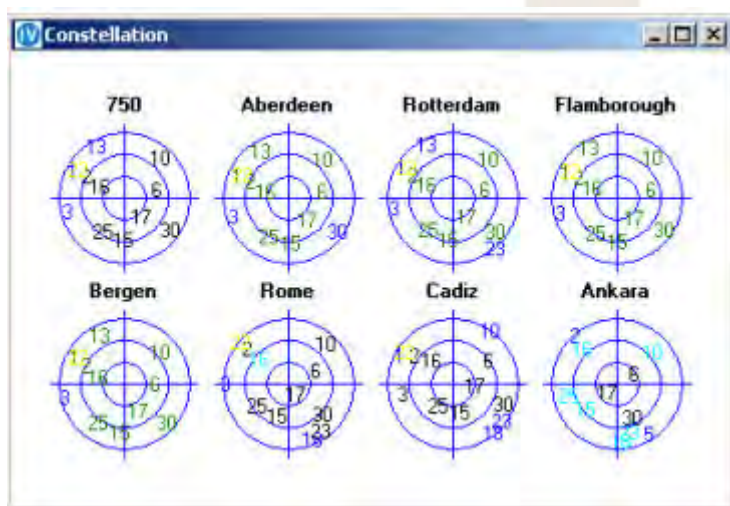

The outer ring of each Bullseye refers to 0° elevation and the centre is the zenith. The bottom centre of the SV numbers text is the current position, as shown below:

14

The satellite numbers are colour coded.

- Black - indicates **L1** and **L2** corrections are available for use in a calculation.
- Green - indicates L1 data only is available for use.
- Light Blue - indicates a satellite is expected but no corrections for that satellite have yet been acquired.
- Dark Blue - indicates the SV is below the elevation cut off.
- Red - indicates a satellite has been disabled in the SV Status dialogue.

- Yellow - indicates an unhealthy SV.

When the window is resized by click and dragging a corner, the program rearranges the constellation displays to best fit the available area.

### 3.4.5.5.Latency

By default this Window does not show the two columns “Arrival Latency” and “Update Interval” but a right-mouse click allows them to be added.



The right-mouse click also allows the time scale of the Latency columns to be changed and it allows the window to be copied to the clipboard.

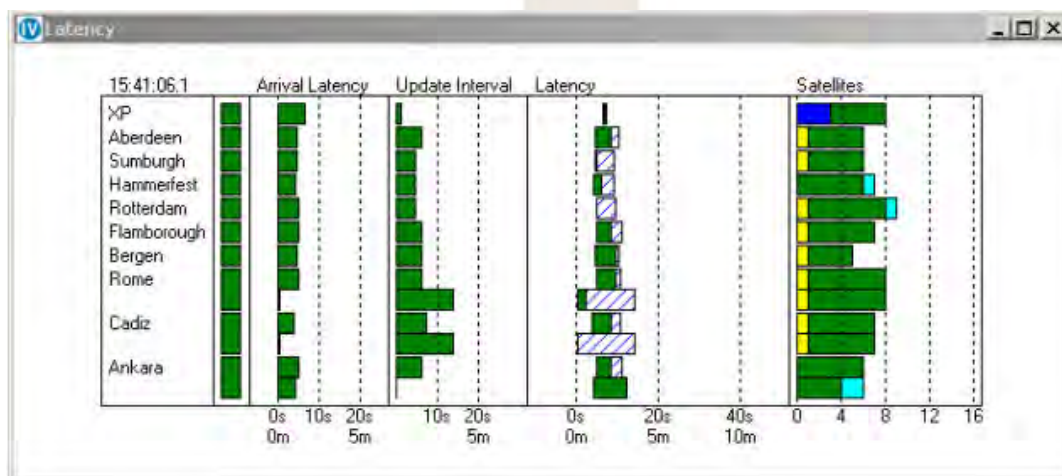

The example above has two rows of information for each dual frequency reference station. The first row refers to Type 1 messages and the second row refers to Type 15 or 55 messages where applicable. These will only appear once messages have been received. The Type 1 rows and Type 15/55 rows have different time scales as can be seen at the bottom of the Latency columns.

The first column after the name of the station will show a green button when the program has received an **RTCM** Type 3 Reference Station position message. This only has to happen once after starting the program. The program will not use RTCM corrections from a reference station without a Type 3 message having been received.

The “Latency” column shows the correction update rate as a bar. The left-hand edge of the bar shows how old the current correction was when first received by MultiFix. It is a measure of the efficiency of the correction delivery system. (The corrections are time stamped with **GPS** time by the reference station, and as MultiFix also has access to GPS time the age of the corrections at the time of receipt is known). The right-hand side of the bar advances until a new correction is received showing the age of the current correction. The bar also shows a hatched area showing the update rate of the last correction received.

For Type 1 messages:

- Bars will be green if the last correction was received in less than 25 seconds.
- They will be yellow between 25 and 37½ Seconds.
- They will be red if older than 37½ seconds. After 50 seconds the corrections from that reference station will no longer be deemed usable.

For Type 15/55 messages:

- The bars will be green if the last correction was received in less than 5 minutes.
- They will be yellow if received between 5 minutes and 7½ minutes.
- They will be red if older than 7½ minutes. Type 55 information is considered stale if it is more than 10 minutes old.

The “Latency” panel has a negative area. Some GPS correction systems (not SkyFix) try to predict corrections for a point of time in the future when a correction is to be used. If a fast data transfer system is used the corrections can arrive with a time stamp earlier than current time, in which case the bar will start in the negative portion of the panel.

The optional “Arrival Latency” and “Update Interval” panels contain data extracted from the “Latency” panel.

In “Arrival Latency” the right-hand end of the bar shows how old the current corrections were when received by MultiFix.

In “Update Latency” the bar shows how long elapsed between the receipt of the current and previous correction messages.

The “Satellites” column shows how many satellites (viable for use by MultiFix) can be seen at each reference station.

The colour coding is: -

- Green - correction data has been received for the expected satellite(s).
- Yellow - the satellite(s) are unhealthy.
- Dark blue – the satellite(s) is in the high scale factor mode, i.e. the resolution is 32cms as opposed to 2cms. This is usually caused by a rate value greater than  $\pm 0.256\text{m/sec}$ .
- Light blue (Aqua) - no corrections have been received for one or more expected satellites, i.e. it is missing.
- Red - the satellite(s) has been disabled by the user in the SV Status dialogue.

In XP mode the following applies:

The whole bar indicates the total number of satellites in view at the GPS receiver.

- Green – Number of satellites with valid clock correction update received.
- Dark Blue - Number of satellites with no current clock correction update.

It is normal for this figure to vary as the corrections arrive in batches that include corrections for some SV's not currently visible. The received corrections are shown in [“View” \ “Corrections” \ “Orbit Data” \ “Data Table”](#) as black numbers in the “Clk” column.

#### 3.4.5.5.6.Type 16

***RTCM Type 16 messages are free text messages sent over the data link as part of the RTCM message. The SkyFix Network Control Centres (NCC's) send out messages to warn users of planned maintenance at stations or of known outages using the Type 16 facility.***

When a Type 16 message is received an acknowledgment box will appear containing the text message.

This can be closed by clicking the acknowledge button.



The alert box function can be disabled under ["Options" / "Type 16 Alert"](#).

The Recent Type 16s window allows the user to review all messages received in the past 24 hours

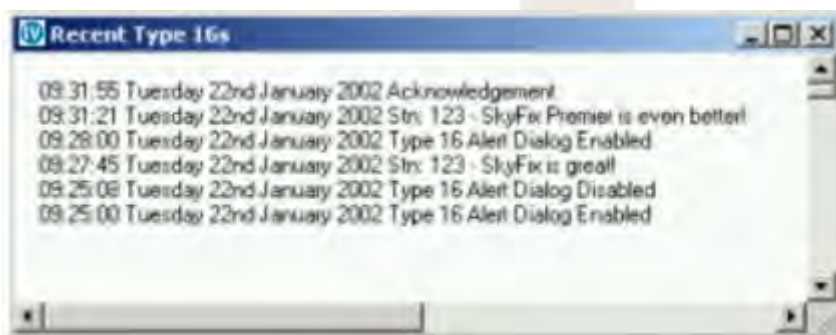

In addition, all received Type 16 messages are stored in a text file with a file name consisting of the configuration name and the days date (yyyymmdd), as below:

Configuration name\_date\_type16.txt

A new file will be generated every day at midnight **UTC**.

The files will be stored in the same directory as the current configuration.

### 3.4.5.5.7.Starfix Beams

Beam	Azimuth	Elevation
Atlantic Ocean Region (East)	200	27
25 East High Power	151	25
Europe Spot	151	25
Atlantic Ocean Region (West)	241	11
Atlantic Ocean (West) High Power	241	11
Indian Ocean Region	111	7

This calls up the “Starfix Beams Elevation and Azimuth” display. This window includes the elevation and azimuth to each of the currently visible Starfix satellites, based on the users current location.

### 3.4.5.6. Calculations

#### 3.4.5.6.1. Status

The Calculations Status window shows the status of the calculations.

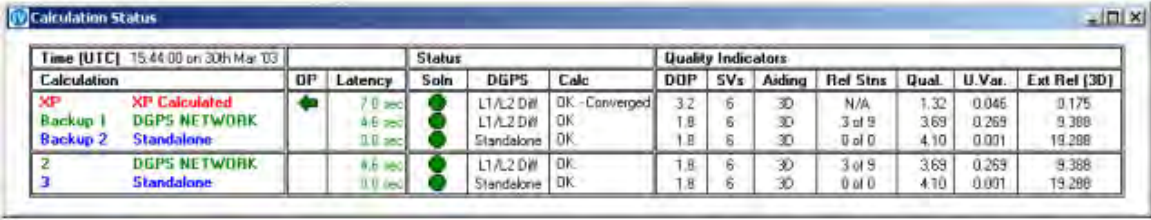

Time (UTC)		Status		Quality Indicators								
Calculation	OP	Latency	Soln	DGPS	Calc	DOP	SVs	Aiding	Ref Stns	Qual.	U.Var.	Ext Ref (3D)
XP	XP Calculated	7.0 sec	Green	L1/L2 Diff	OK - Converged	3.2	6	3D	N/A	1.32	0.046	0.175
Backup 1	DGPS NETWORK	4.6 sec	Green	L1/L2 Diff	OK	1.8	6	3D	3 of 9	3.69	0.269	9.388
Backup 2	Standalone	0.0 sec	Green	Standalone	OK	1.8	6	3D	0 of 0	4.10	0.001	19.288
2	DGPS NETWORK	4.6 sec	Green	L1/L2 Diff	OK	1.8	6	3D	3 of 9	3.69	0.269	9.388
3	Standalone	0.0 sec	Green	Standalone	OK	1.8	6	3D	0 of 0	4.10	0.001	19.288

In the “Calculation” section the solutions currently set up are displayed. If **SkyFix XP** mode is selected in “Config” \ “Calc” \ “Settings”, and a primary (and secondary if applicable) back-up source has been selected, then these will appear in the top box. All other solutions will be shown in the lower box.

In XP mode an “OP” (Output) column is also shown which displays, in the form of a green arrow, which solution is currently being used as the XP solution. In the situation above the “XP Calculated” position was being output. The transition between solutions is restricted to 1cm per epoch to prevent any jump in the output position, during this period the arrow is yellow.

The “Latency” column displays the update rate of the corrections for each solution.

The “Status” section contains three columns. “Soln” indicates the status of the solution by using an easily visible ‘traffic light’ system.

- **Green** – The solution is good.
- **Yellow** – The latency is too high (>25 seconds and <37.5 seconds) [If in SkyFix XP mode then it can also be yellow if the solution is still converging]
- **Red** - Latency is >37.5 seconds.

The “DGPS” column states the type of solution:

- **L1 Diff** – Single frequency **RTCM** corrections received
- **L1/L2 Diff** – Dual frequency RTCM corrections received



- **Standalone** – No RTCM corrections received

The “Calc” column can contain the following:

- **OK** – Position solution is good.
- **No Ephem** – No Ephemeris data received.
- **Too Few Meas** – Enough SV’s in view but some expected measurements are missing. (Standalone and **DGPS** need a minimum of 4 SV’s, XP requires a minimum of 5).
- **Too Few SVs** – Not enough SV’s in view.
- **Too Few Ephem** - Enough measurements but not enough Ephemeris data
- **No Diff** - No differential corrections received for a calculation requiring corrections. This will appear after receiving no corrections for more than 50 seconds.
- **Diff Too Old** - Differential Corrections are more than 30 seconds old.
- **Too Few Diff** - Not enough differential corrections to correct the calculation
- **Singular** - Can be seen when experiencing very bad satellite **constellation**, i.e. all in a narrow arc, or when reference station is geometry poor.
- **Divergent** - The least squares solution of the position is moving more than 1 millimetre after ten iterations.
- **Not Required** – No GPS data received.

If in SkyFix XP mode then the following messages can also appear:

- **OK – Converging** – XP corrections are being received and the solution is converging.
- **OK – Converged** – XP solution has converged below the level specified in “Config” \ “Calc” \ “SkyFix XP...”

The “Quality Indicators” section shows various statistical values on the performance of the corresponding solutions.

- **DOP** - If there is no height aiding in the calculation it contains the **PDOP**, if height aided then it will contain the **HDOP**.
- **SVs** – The number of viable satellites
- **Aiding** – The method of height aiding employed by the solution. “3D” indicates no height aiding, “H+” indicates height aiding is being used
- **Ref Stns** – The number of reference station currently used out of the ones selected.
- **Qual.** - is the 3D a priori 50% radial error.



- **U. Var.** - is the unit variance. If the size of calculation's residuals are as expected the Unit Variance will be 1.
- **Ext Rel.** – is the largest 2D error present, possibly resulting from an undetected outlier existing in the calculation.

- 

### 3.4.5.6.2.Positions

Displays the result of an active computation. When a new position window is opened it will default to show the first calculation. To select a different calculation, right click on the window to call up the dialog.

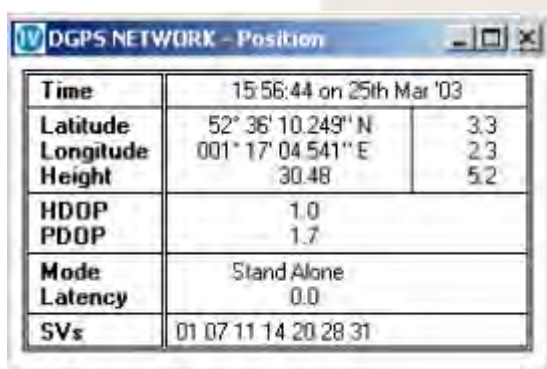

DGPS NETWORK - Position	
<b>Time</b>	15:56:44 on 25th Mar '03
<b>Latitude</b>	52° 36' 10.249" N 3.3
<b>Longitude</b>	001° 17' 04.541" E 2.3
<b>Height</b>	30.48 5.2
<b>HDOP</b>	1.0
<b>PDOP</b>	1.7
<b>Mode</b>	Stand Alone
<b>Latency</b>	0.0
<b>SVs</b>	01 07 11 14 20 28 31

The column beside Latitude, Longitude and Height shows the 95% confidence level. The Height is with respect to the **Geoid** using the **EGM96** model to determine the Geoid / Spheroid separation. Note that if the user has disabled the EGM96 model and entered their own value in the "Config" \ "Calc" \ Settings..." then this figure will be based on the entered value and not the EGM96 Model.

"Mode" can state whether the solution is "XP", "Differential" or "Stand Alone".

"Latency" is the age of the most recent Type 1 (Type 48, 49, or 50 for **SkyFix XP**) message. If the calculation is a multiple reference station solution there may be older corrections used in the solution.

"SVs" are a list of the satellites used in the calculation.

Beware that if the computation fails the window will freeze showing the status at the last update, it will not turn red or clear the information.

### 3.4.5.6.3.XP Offsets

This option becomes available once in SkyFix XP mode. This window is essentially the same as the [“View” \ “Calc” \ “Offsets”](#) with the addition of a “Vertical” window showing height variations in the calculations as vertical bars. The vertical line for each calculation indicates the 2 x Standard Deviation (95%) either side.

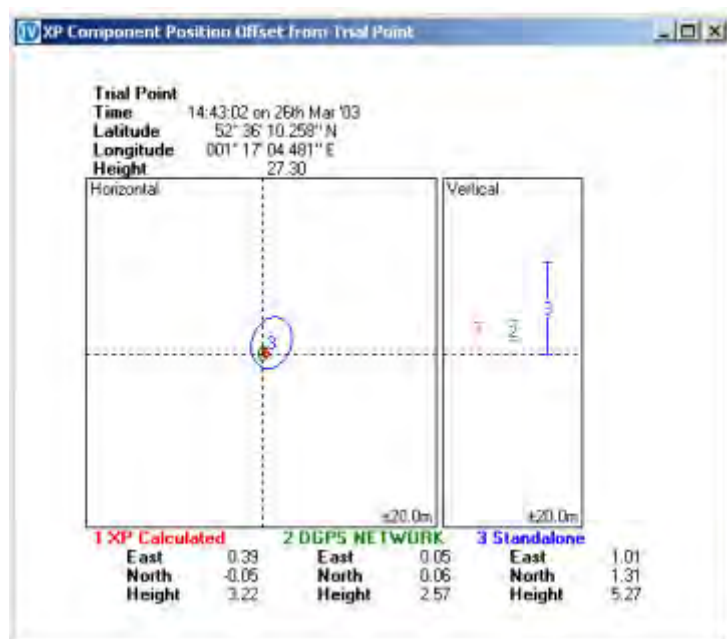

All other options are identical to the [“View” \ “Calc” \ “Offsets”](#) window.

### 3.4.5.6.4.Offsets

This window shows the delta East, North and Height and the error ellipse. The error ellipse is at the 95% confidence level.

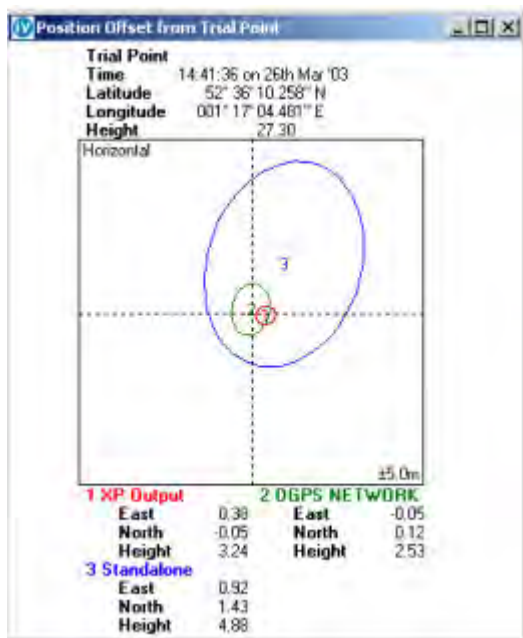

As well as being copied and saved, the window has other options that are available by clicking the right-mouse button.

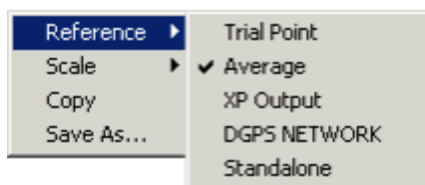

The first concerns the Origin to which the data is referenced point. It can be the Average of all the calculations, a static point, or any available computation.

The Average Latitude, Longitude and Height figure is not a mean but a weighted average. The Height is with respect to the **Geoid**.

The Trial Point is a static point as entered under "Config" \ "Calc" \ "Settings...". If this is changed while a window referenced to the trial point is open the origin of the display will move.

The data can also be referenced to any one of the available calculations.

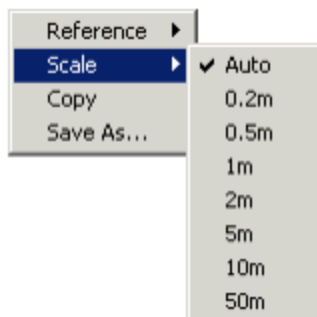

The scale of the display can be set to be 0.2, 0.5, 1, 2, 5, 10, or 50 metres from the centre to each edge. Alternatively it can be set to “Auto” in which case it will re-scale as required to show all the calculated positions and the error ellipses around those positions.

The information below the display shows the distance of each computation away from the origin.

#### 3.4.5.6.5. Residuals

This screen shows the Lines Of Precision (**LOP**) of the satellite ranges used in the position calculation. Each source of data is represented in a different colour. SV numbers are shown on each LOP in the appropriate colour for each reference station. The actual calculated position is at the intersection of the dashed lines in the centre of each view.

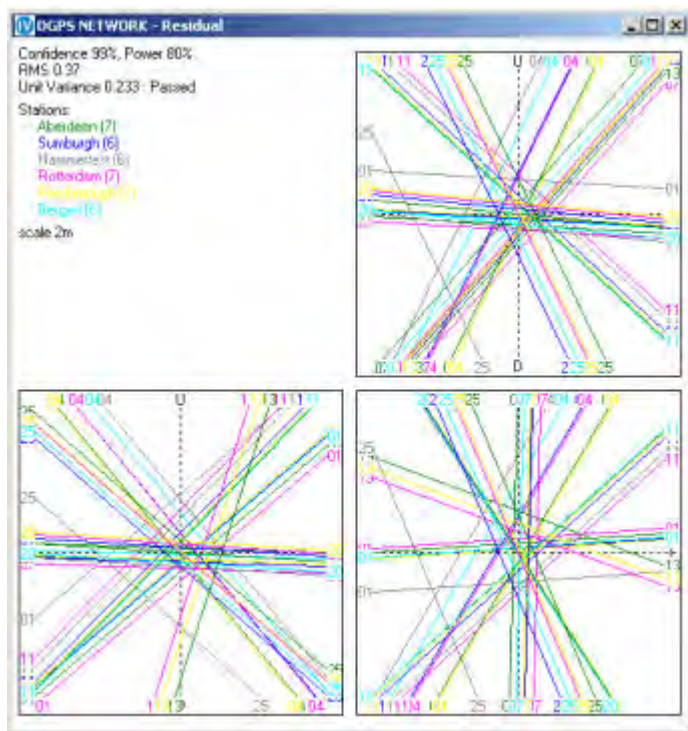

The graphs represent three sections through the calculated position.

The bottom right panel is a North Up Plan Display

The top right panel is a vertical section viewed from the South.

The bottom left panel is a vertical section viewed from the East.

The scale (shown under the "stations" list) changes automatically according to the spread of the LOP's.

If more than one [position calculation](#) has been defined it is possible to switch between them by right-mouse clicking and then selecting the desired calculation.

Solution QC information is also provided. The values are derived from statistical tests and give an indication of how well the solution has been formed using the measurements available.

Confidence and Power are parameters used to define different tests of reliability as recommended by **UKOOA**. The Confidence value provides a number (3 standard deviations from the mean) with which the **W-Test** may be performed. The W-Test, combined with the Power, enables the program to calculate the Marginally Detectable error (MDE). This value may then be used to calculate the reliability of the measurement.

Unit Variance reflects the level of error between the actual and modelled values. **It is independent of quality** providing an indication of the reasonable performance of the program. As such there are no set 'Pass' or 'Fail' values for unit variance. The program takes into consideration parameters such as satellite geometry and amount of data used in order to derive a value. A "Fail" may result from large outliers in the measurements. These are easily identifiable from the section graphs.

**RMS** is the root mean square of the residuals.

The number in brackets next to the **RTCM** station name is the number of satellites that are common to both the current position and the reference station.

### 3.4.5.6.6.UKOOA Stats

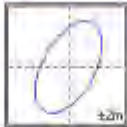
Station	RTCM	PRN	Elev.	Resid.	SD	Nom. Resid.	MDE	Azi.	3D MDE	2D Pos	W Pass												
<table border="1" style="width: 100%; border-collapse: collapse;"> <tr> <td>Latitude</td> <td>52° 36' 10.271" N</td> </tr> <tr> <td>Longitude</td> <td>001° 17' 04.484" E</td> </tr> <tr> <td>Height</td> <td>31.82</td> </tr> <tr> <td>F-Test</td> <td>Pass</td> </tr> <tr> <td>Unit Var.</td> <td>0.101</td> </tr> <tr> <td>Est. Rel (2D)</td> <td>1.133</td> </tr> </table> 												Latitude	52° 36' 10.271" N	Longitude	001° 17' 04.484" E	Height	31.82	F-Test	Pass	Unit Var.	0.101	Est. Rel (2D)	1.133
Latitude	52° 36' 10.271" N																						
Longitude	001° 17' 04.484" E																						
Height	31.82																						
F-Test	Pass																						
Unit Var.	0.101																						
Est. Rel (2D)	1.133																						
Shannon	725	1	29°	-0.24	1.72	0.14	7.29	022°	0.94	0.66	Pass												
		7	39°	0.35	1.13	0.31	3.43	140°	0.65	0.36	Pass												
		11	55°	-0.21	1.03	0.21	3.01	275°	0.36	0.30	Pass												
		20	75°	0.00	0.77	0.00	4.53	197°	0.72	0.13	Pass												
		25	18°	0.23	4.35	0.05	15.52	224°	0.34	0.25	Pass												
Abesjorn	700	1	29°	-0.94	1.95	0.56	7.01	023°	0.98	0.75	Pass												
		7	39°	0.33	1.05	0.31	5.03	123°	0.57	0.40	Pass												
		11	55°	0.09	0.94	0.09	4.54	280°	0.42	0.28	Pass												
		14	10°	1.52	22.58	0.07	77.32	206°	0.09	0.07	Pass												
		20	76°	0.04	0.72	0.06	4.15	150°	0.83	0.06	Pass												
Sumburgh	710	1	29°	0.80	1.87	0.43	7.67	023°	0.98	0.67	Pass												
		7	39°	-0.17	1.12	0.15	5.92	127°	0.63	0.37	Pass												
		11	55°	0.04	1.02	0.03	4.87	292°	0.39	0.26	Pass												
		14	10°	2.58	17.25	0.15	59.51	206°	0.12	0.10	Pass												
		20	76°	0.21	0.77	0.35	4.42	139°	0.77	0.06	Pass												
Trairsteden	740	1	29°	0.78	1.14	0.65	5.84	024°	1.41	1.07	Pass												
		7	39°	-0.33	0.88	0.38	4.24	130°	0.62	0.51	Pass												
		11	55°	0.01	0.65	0.01	3.54	285°	0.57	0.36	Pass												
		14	10°	1.54	36.89	0.04	122.73	206°	0.06	0.05	Pass												
		20	76°	-0.11	0.57	0.19	3.37	153°	1.07	0.12	Pass												
Flatborough	750	1	29°	0.15	1.08	0.14	5.25	023°	1.49	1.13	Pass												
		7	39°	0.04	0.75	0.06	3.82	130°	0.93	0.57	Pass												
		11	55°	0.15	0.66	0.22	3.38	287°	0.67	0.40	Pass												
		14	10°	0.45	31.42	0.01	107.48	206°	0.07	0.05	Pass												
		20	76°	-0.11	0.52	0.21	3.18	156°	1.16	0.11	Pass												
Scalby	760	1	29°	0.12	1.63	0.07	7.02	022°	0.98	0.72	Pass												
		7	39°	0.06	1.16	0.05	5.47	139°	0.60	0.37	Pass												
		11	55°	0.15	1.00	0.15	4.89	275°	0.39	0.29	Pass												
		20	76°	-0.19	0.77	0.25	4.49	190°	0.74	0.13	Pass												
		25	18°	0.17	3.15	0.05	11.61	223°	0.46	0.34	Pass												
Bronnstrand	770	1	29°	0.55	2.33	0.25	8.76	023°	0.75	0.56	Pass												
		7	39°	1.12	1.15	0.94	5.98	123°	0.60	0.35	Pass												
		11	55°	-0.52	1.06	0.59	5.07	299°	0.37	0.25	Pass												
		14	10°	5.62	17.26	0.33	59.30	206°	0.12	0.10	Pass												
		20	76°	0.00	0.81	0.01	4.64	094°	0.72	0.08	Pass												
Beigin	780	1	29°	-0.57	1.90	0.30	7.75	023°	0.97	0.66	Pass												
		7	39°	0.94	1.17	0.80	5.44	127°	0.61	0.36	Pass												
		11	55°	0.42	1.01	0.41	4.87	293°	0.39	0.26	Pass												
		14	10°	2.65	17.34	0.15	59.48	206°	0.12	0.10	Pass												
		20	76°	0.24	0.78	0.31	4.47	129°	0.76	0.06	Pass												
	25	18°	0.44	1.96	0.24	7.71	224°	0.74	0.53	Pass													

The **UKOOA** Stats provide a more rigorous analysis of the computations, and more specifically, the corrections used.

The calculation to be displayed can be selected by right clicking the window.

If “Freeze” is selected the current window display is held and frozen appears in the windows title bar. Clicking “Freeze” again unfreezes the display.

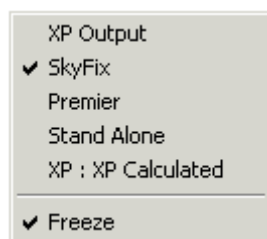

The display is divided into three parts.

1. The top left contains a summary table of the position and basic QC results.
2. The top centre contains a graphical plot of current error ellipse.
3. The bottom of the display contains the main results table including all of the UKOOA test results.
  - The Summary table includes current position, **F-test** result, the unit variance and the computed external reliability.

F-Test	is a test applied to the unit variance. There is no fixed ‘Pass’ or ‘Fail’ values for unit variance. The program takes into consideration parameters such as satellite geometry and amount of data used in order to derive a value. A “Fail” may result from large outliers in the measurements.
Unit Variance	reflects the level of error between the actual and modelled values. It is independent of quality providing an indication of the reasonable performance of the calculation.
External Reliability	External reliability is assessed by calculating the effect that an undetected outlier (with the Magnitude of the MDE figure) will have on horizontal position. It is considered to be a more useful concept than internal reliability, hence its

recommended use by UKOOA as the most suitable measure of Reliability.  
External reliability is measured in metres.

- The Graphical Plot display contains the same error ellipse as is displayed in the "View" \ "Calc" \ "Offset" display.
- The Main Table contains a number of details as listed below.

If Height Aiding is enabled the first line will be for Height. The "Residual" displayed is the difference between the entered height and the computed height for the selected calculation.

***SD for that residual is the value entered by the user under "Config" \ "Calc" \ "Settings..." when height aiding was first set up.***

The additional rows are for the corrections for each satellite from each individual station used in the calculation.

Residual	is the difference between the calculated range, based on the position solution, and the observed range.
SD	is the standard deviation for the residual
Normalised Residual	is the Residual divided by the standard deviation. This forms the basis of the <b>W-test</b> and as such is a more accurate indicator of whether the observation is a potential outlier.
MDE	is Marginally Detectable Error. This is the smallest outlier that is likely to be detected by the current solution. This therefore is the internal reliability.

The next four columns represent the external reliability. This is the effect that each potential undetected outlier, as defined by the MDE, may have on the position solution. The three columns represent:

Azimuth	is the orientation of any potential error in 2D
3D MDE	is the effect of the potential error with the size of an MDE on the calculation in 3D
2D Pos	is the effect of the potential error with the size of an MDE on the calculation in 2D, i.e. the horizontal plane.
W Pass	is a pass-fail status window for the W-Test



### 3.4.5.6.7. Time Series Plots

This facility provides time series plots, scatter plots and histograms. All the graphs have a time constant of 60 minutes.

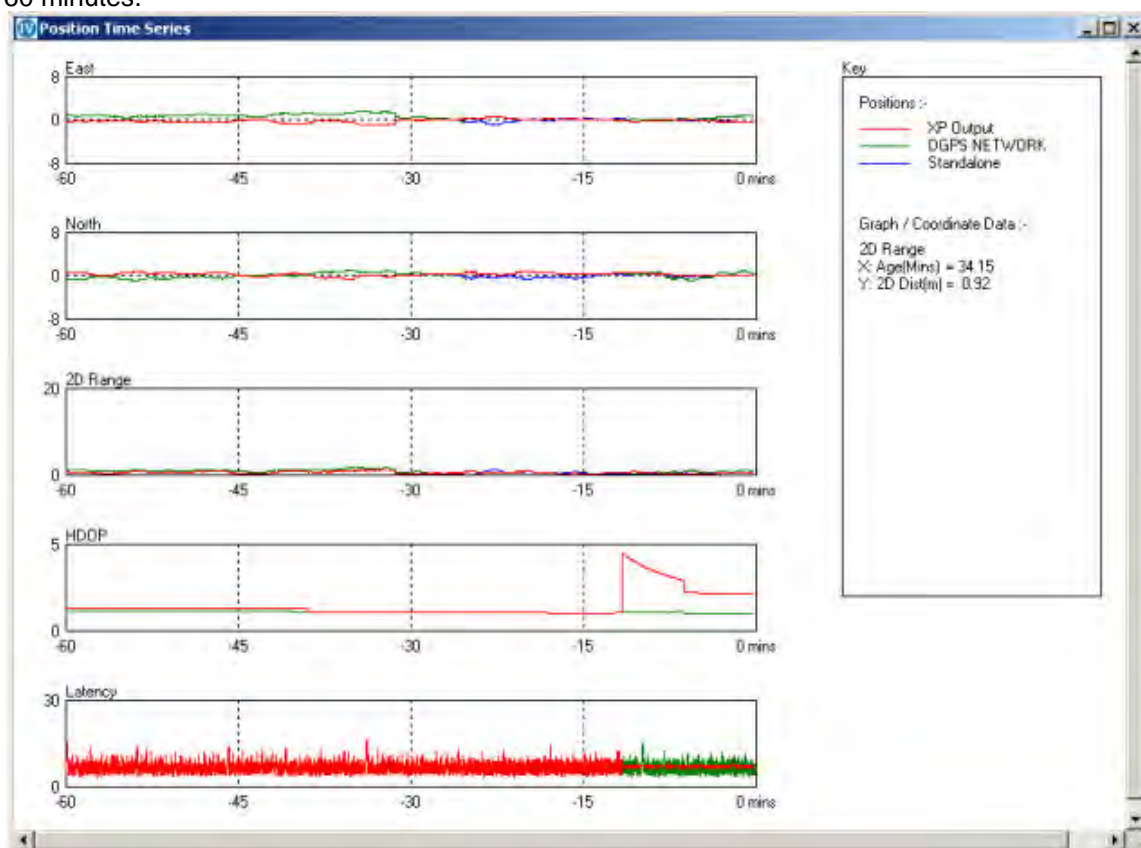

The window opens with a default status. What is shown and how it is displayed can be changed by a right-mouse click when the cursor is in the window. That provides access to the options shown below.

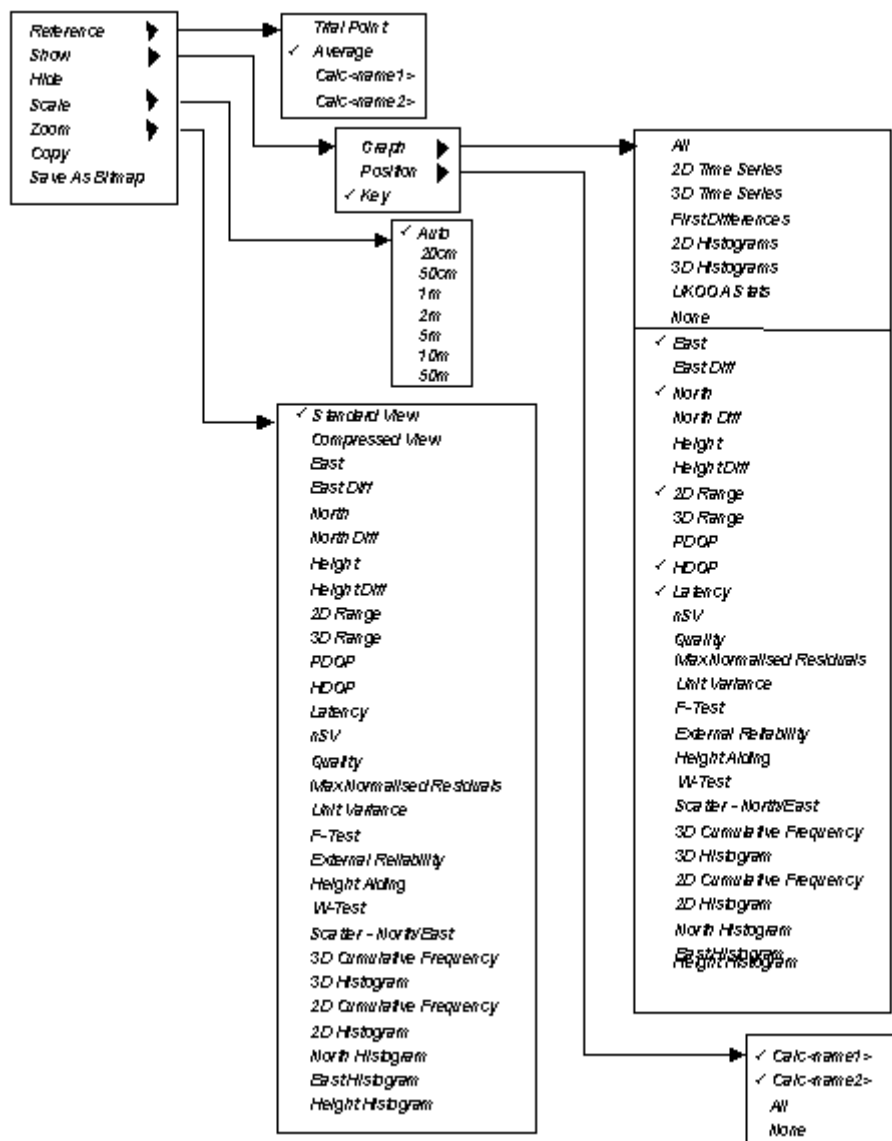

“Reference” allows the origin of the graphs displayed in the window to be changed.

“Trial Point” takes the Calculation Trial Point as the origin

“Average” takes the weighted mean of all the calculations

“Calc<name1>” takes the position formed by that named calculation.

“Show” / “Graph” allows an individual selection of what is to be shown in the window.

- “Show” / “Graph” / “All” puts all possible graphs into the window. This is not very practical because not all graphs can fit into the maximum window size.

“Show” / “Graph” / “2D Time Series”, “Show” / “Graph” / “3D Time Series”, “Show” / “Graph” / “First Differences”, “Show” / “Graph” / “2D Histograms”, “Show” / “Graph” / “3D Histograms”, and “Show” / “Graph” / “UKOOA Stats” are all quick ways of making a reduced graph selection.

- “Show” / “Graph” / “2D Time Series” is the default selection when the window is first opened. This option includes the time series plots East, North, 2D Range, HDOP, Latency and nSV.
- “Show” / “Graph” / “3D Time Series” option opens East, North, Height, 3D Range, PDOP, Latency and nSV.
- “Show” / “Graph” / “First Differences” opens East Diff, North Diff and Height Diff.
- “Show” / “Graph” / “2D Histograms” opens Scatter – North/East, 2D Cumulative Frequency, 2D Histogram, North Histogram and East Histogram.
- “Show” / “Graph” / “3D Histograms” opens Scatter – North/East, 3D Cumulative Frequency, 3D Histogram, North Histogram, East Histogram and Height Histogram.
- “Show” / “Graph” / “UKOOA Stats” opens Max. Normalised Residuals, Unit Variance, F-Test, External Reliability, Height Aiding and W-Test.
- “Show” / “Graph” / “None” switches all of the current graph displays off.

A tick against the graph name indicates it is included in the window. Individual graphs can be added or removed from the window by clicking their individual names.

“Show” / “Position” defaults with All calculations selected for inclusion in the graphs. The data for each calculation is colour coded and the key legend box shows the colours used against the calculation names.

- “Show” / “Position” / “All” toggles all available calculations on.
- “Show” / “Position” / “None” toggles all available calculations off.
- “Show” / “Key” turns the key legend box off and on.

Hide will close the graph that the mouse cursor is over when the right mouse button is clicked.

“Scale” can be set to Auto, 20cm, 50cm, 1m, 2m, 5m, 10m or 50m metres. Auto ensures that graphs re-scale to show all the data over the last 60 minutes. Setting a scale distance will affect those graphs where either the X or Y axis (or in the case of the scatter plot both X and Y axes) is a distance. Graphs showing HDOP, PDOP Latency and nSV (number of satellites) will not be affected by selecting the scale.

“Zoom” defaults to the Standard View in which each graph has X and Y axis labels. This limits the number of graphs that can be shown in the window. Selecting the Compressed View option removes the space between the graphs and the axis labels. Those labels are then shown in the key legend box. Alternatively a single graph can be selected which will fill the whole window. This can also be achieved by double clicking on the required graph when in the standard view.

An example of the Compressed View display is shown below. The scale of the graphs is included in the key legend box in addition to the mouse cursor position, in terms of X and Y of the graph the cursor is over.

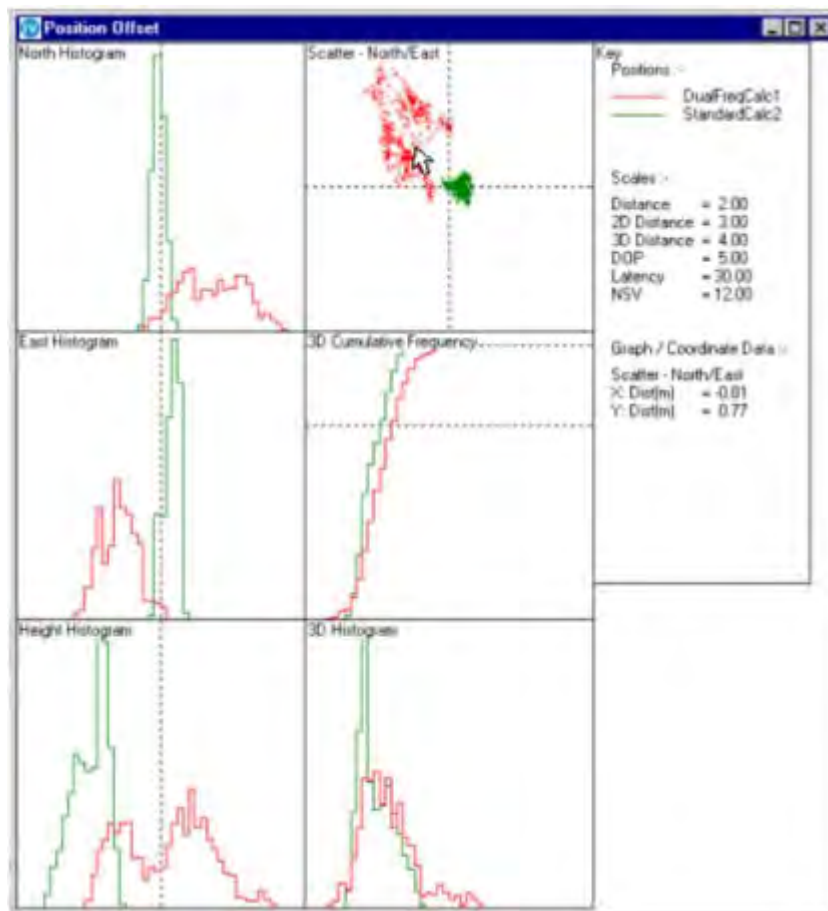

If a graph is to be viewed in more detail it can be selected individually in the Zoom selection menu. Any graph can be called up and it will fill the window, it does not need to be already open. To zoom into a graph that is already displayed double-click on the desired graph. To revert to the original display double-click on the graph again.

The graphs available are: -

East	is a times series plot of the difference in Eastings between the calculated Eastings and the graph's Eastings origin.
East Diff	is a times series plot of the difference in Eastings epoch to epoch.
North	is a time series plot of the difference in Northings between the calculated Northings and the graph's Northings origin.
North Diff	is a times series plot of the difference in Northings epoch to epoch.
Height	is a time series plot of the difference in Height between the calculated Height

	and the graph's Height origin.
Height Diff	is a times series plot of the difference in Height epoch to epoch.
2D Range	is a time series plot of the two dimensional radial distance between each calculation's position and the origin position.
3D Range	is a time series plot of the three dimensional radial distance between each calculation's position and the origin position.
PDOP	is a time series plot of the Positional Dilution of Precision value for each calculation.
HDOP	is a time series plot of the Horizontal Dilution of Precision value for each calculation.
Latency	is a time series plot of the age of the most recent RTCM Type 1 (Type 48, 49, 50 for XP) message received prior to the time each calculated position was formed. It's Y axis does not re-scale it is fixed at 30 seconds.
nSV	is a time series plot of the number of satellites used in a calculation.
Quality	is a time plot of the Qual value in the "View" \ "Calc" \ "Status" dialogue.
Max. Normalised Residuals	is a time series plot of largest Normalised residual for the selection calculation.
Unit Variance	is a time series plot of the unit variance.
F-Test	is a time series plot of the F-test.
External Reliability	is a time series plot of the largest error, in 2D, that might result due to an undetected outlier existing in the calculation.
Height Aiding	is a time series plot indicating if the solution is in height aiding mode or not.
W-Test	is a time series plot of the W-test. The W-test result is either a pass or fail.
Scatter – North/East	is a scatter plot two dimensional display of the calculated positions with respect to the origin of the plot.
3D Cumulative Frequency	is a graph showing the percentage of the time over the last 60 minutes that the three dimensional radial distance has been with n metres of the origin position. The 1 and 2 sigma lines are shown.
2D	is a graph showing the percentage of the time over the last 60 minutes that

Cumulative Frequency	the two dimensional radial distance has been with n metres of the origin position. The 1 and 2 sigma lines are shown.
3D Histogram	is a histogram of the three dimensional radial distance between each calculated position and the origin position.
2D Histogram	is a histogram of the two dimensional radial distance between each calculated position and the origin position.
North Histogram	is a histogram of the difference in Northings between each calculated position and the origin's Northings.
East Histogram	is a histogram of the difference in Eastings between each calculated position and the origin's Eastings.
Height Histogram	is a histogram of the difference in Height between each calculated position and the origin's Height.

Remember that the time constant for the data in all these graphs is 60 minutes.

### 3.4.5.7. Event Log

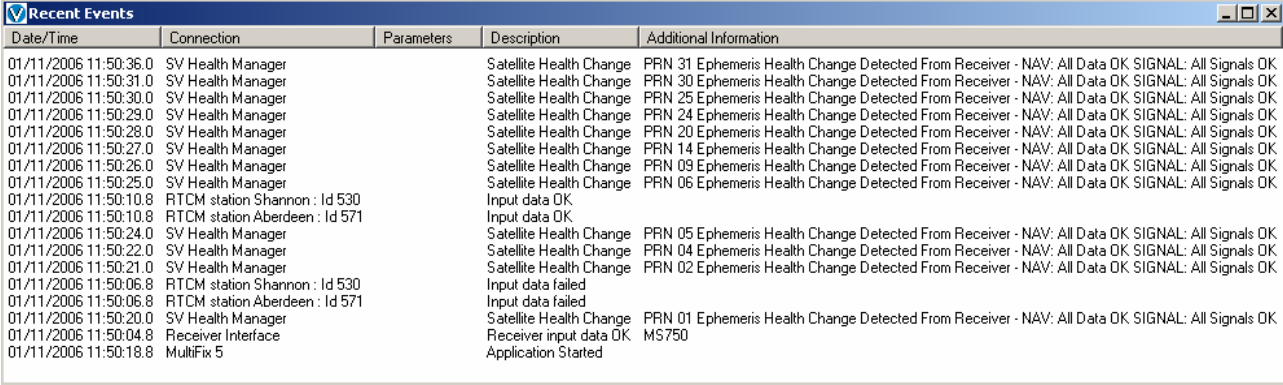

Date/Time	Connection	Parameters	Description	Additional Information
01/11/2006 11:50:36.0	SV Health Manager		Satellite Health Change	PRN 31 Ephemeris Health Change Detected From Receiver - NAV: All Data OK SIGNAL: All Signals OK
01/11/2006 11:50:31.0	SV Health Manager		Satellite Health Change	PRN 30 Ephemeris Health Change Detected From Receiver - NAV: All Data OK SIGNAL: All Signals OK
01/11/2006 11:50:30.0	SV Health Manager		Satellite Health Change	PRN 25 Ephemeris Health Change Detected From Receiver - NAV: All Data OK SIGNAL: All Signals OK
01/11/2006 11:50:29.0	SV Health Manager		Satellite Health Change	PRN 24 Ephemeris Health Change Detected From Receiver - NAV: All Data OK SIGNAL: All Signals OK
01/11/2006 11:50:28.0	SV Health Manager		Satellite Health Change	PRN 20 Ephemeris Health Change Detected From Receiver - NAV: All Data OK SIGNAL: All Signals OK
01/11/2006 11:50:27.0	SV Health Manager		Satellite Health Change	PRN 14 Ephemeris Health Change Detected From Receiver - NAV: All Data OK SIGNAL: All Signals OK
01/11/2006 11:50:26.0	SV Health Manager		Satellite Health Change	PRN 09 Ephemeris Health Change Detected From Receiver - NAV: All Data OK SIGNAL: All Signals OK
01/11/2006 11:50:25.0	SV Health Manager		Satellite Health Change	PRN 06 Ephemeris Health Change Detected From Receiver - NAV: All Data OK SIGNAL: All Signals OK
01/11/2006 11:50:10.8	RTCM station Shannon : Id 530		Input data OK	
01/11/2006 11:50:10.8	RTCM station Aberdeen : Id 571		Input data OK	
01/11/2006 11:50:24.0	SV Health Manager		Satellite Health Change	PRN 05 Ephemeris Health Change Detected From Receiver - NAV: All Data OK SIGNAL: All Signals OK
01/11/2006 11:50:22.0	SV Health Manager		Satellite Health Change	PRN 04 Ephemeris Health Change Detected From Receiver - NAV: All Data OK SIGNAL: All Signals OK
01/11/2006 11:50:21.0	SV Health Manager		Satellite Health Change	PRN 02 Ephemeris Health Change Detected From Receiver - NAV: All Data OK SIGNAL: All Signals OK
01/11/2006 11:50:06.8	RTCM station Shannon : Id 530		Input data failed	
01/11/2006 11:50:06.8	RTCM station Aberdeen : Id 571		Input data failed	
01/11/2006 11:50:20.0	SV Health Manager		Satellite Health Change	PRN 01 Ephemeris Health Change Detected From Receiver - NAV: All Data OK SIGNAL: All Signals OK
01/11/2006 11:50:04.8	Receiver Interface		Receiver input data OK	MS750
01/11/2006 11:50:18.8	MultiFix 5		Application Started	

This dialogue shows a history of events that have occurred since MultiFix was started. The type of events that can be seen are shown below:

- “Receiver Interface” – “Receiver input data failed”, “Receiver input data OK”.
- “SV Health Manager” – “Satellite health change”.
- “Datagram Monitor” – “Datagram error”.
- “Orbit Correction Applet” – “Source changeover”, “RTCM data failed”, “RTCM data OK”.

- “**RTCM Station XXXXX : Ident XXX**” – “Input data OK”, “Input data failed”.
- “**XP Calculation**” – “Transition Completed”

The Event Log will also be saved as a text file in the folder where the current MultiFix configuration file is saved.

The file will be named with the format:

<ConfigFileName>\_<YYYYMMDD>\_EventLog.txt

e.g. Setup001\_20030401\_EventLog.txt



## 3.4.6. Options

### 3.4.6.1. Lock

If the Lock option is chosen “File” and “Config” are removed from the menu bar. Whilst locked, “Options” \ “Lock” changes to “Options” \ “Unlock”. This reinstates “File” and “Config” if selected.

### 3.4.6.2. Colour

If different colour schemes are required they can be set up here. Ensure that a false impression is not given when changing the colour coding, in particular relating to errors.

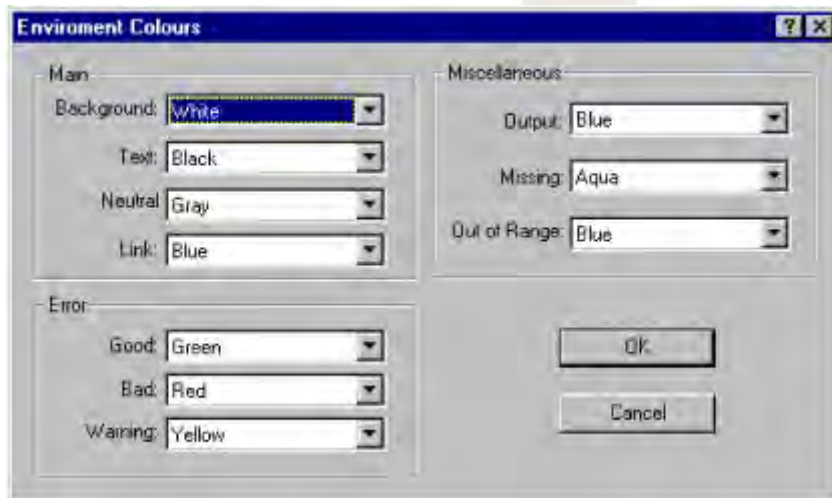

Some of the selections do not affect all view windows.

- “Main”  
“Background” and “Text” change the windows background and text colours.  
“Neutral” is used in the Latency window to show period when update may be expected.  
“Link” is not currently used.
- “Error”.  
Various windows have stages of error state, these colours relate to them.  
“Good”, “Bad” and “Warning”.
- “Miscellaneous”  
“Output” as seen in the IO status and IO Scroller windows.



“Missing” as seen in the Latency and **Constellation** windows.

“Out of Range” as seen in the Latency and Constellation windows when a satellite is below the mask.

#### 3.4.6.3. Hide Tool Bar

This will hide the shortcut toolbar displayed at the top of the MultiFix screen.

When hidden the option will change to “show toolbar” which will return the toolbar to the screen when selected.

#### 3.4.6.4. Autostart

Selecting this option will affect MultiFix the next time it is launched. With this option ticked, upon launch MultiFix will start up with the last used configuration, rather than starting with an empty configuration.

#### 3.4.6.5. Trial Point Warning

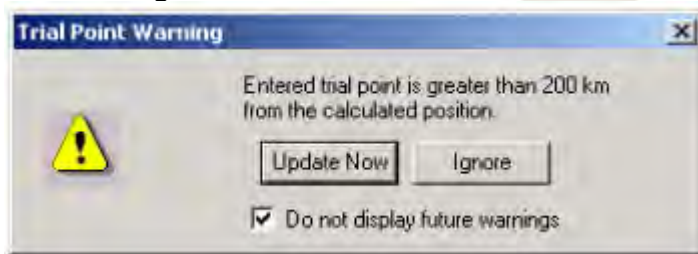

When enabled, MultiFix will check the entered trial point value against the current position. If the trial point is in error of more than 200km a warning dialogue will be displayed, asking the user if they wish to update the trial point.

Clicking **[Update now]** will update the entered trial point to the user current location. **[Ignore]** will retain the old value.

This feature can be disabled from within the dialogue by checking the “Do not display future warning”. The feature can be re-enabled by selecting Trial Point warning from the options Menu.

MultiFix utilises two trial points, the value entered in “Config” \ “Calc” \ “Settings” and the calculation value that is held in the configuration file. Even if an incorrect value for the trial point is retained the calculation will

continue using an up to date position. The stored position is only modified if the user enters a new trial point position.

#### 3.4.6.6. Rinex

This enables or disables the **Rinex** data logging facility, accessible from the “[Logging](#)” \ “[Rinex](#)” menu. When disabled the Rinex option will be not be shown in the logging menu.

#### 3.4.6.7. Type 16 Alert

If the user does not wish to be warned automatically of any Type 16 messages received then the alert dialogue box can be disabled.

More details of the [Type 16 alert](#) dialogue.

The messages will continue to be displayed in the Type 16 history window and written to the Type 16 log file.

If the alert dialogue is disabled a note is written to the log file stating that the feature has been disabled.

A tick mark will appear next to “Type 16 Alert” if it is currently enabled.

#### 3.4.6.8. Event Logger



If the “Event Logger” option is ticked in the “Options” menu then a dialogue box, shown above, will appear automatically to warn the user of any event changes. The warning dialogue will remain on screen until the **[acknowledge]** button is clicked.

See a list of [events displayed](#).

### 3.4.6.9. Replay

By selecting this option, the user will be able to replay [logged data files](#). However, it must be noted that MultiFix will stop its real time operation when in replay mode, with the user prompted to continue.

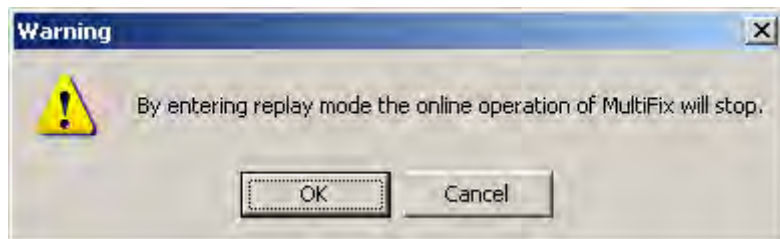

Once in replay mode, a series of options are available. Further information can be found in ["Replay Options"](#)

### 3.4.6.10.P294

Selecting this option will result in [P2/94 Output](#) now being revealed on the configuration menu.

## 3.4.7. Tools

### 3.4.7.1. Position Viewer Wizard

Position Viewer enables the user to compare outputs from MultiFix with data from other systems, such as the Fugro 90964 GLONASS unit, and to automatically select the most stable solution. The Position Viewer Wizard is designed to co-ordinate the configuration of MultiFix and the Position Viewer application.

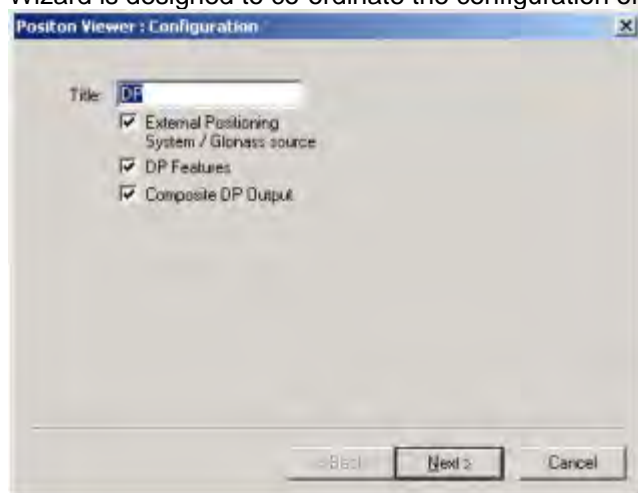

The wizard operates as a series of dialogues. Note that if at anytime an incorrect selection has been made, use [**<Back**] to retrace the steps through the wizard and make the correction.

### Position Viewer Configuration

Enter a title for the configuration. This will be the name of the configuration file in MultiFix.

Check the tick boxes for the features that you require.

The "External Positioning / Glonass Source" option is designed for use with the Fugro 90964 but applies to any external **NMEA** input.

The "DP Features" option will enable the auto select mode for selecting the most stable solution.

The "Composite DP Output" option will enable the Position output option in Position Viewer.

Click [**Next>**] to continue.

### Position Viewer Positions

Select the positions you wish to export to Position Viewer.

Define the socket port number you wish to use to transfer the data

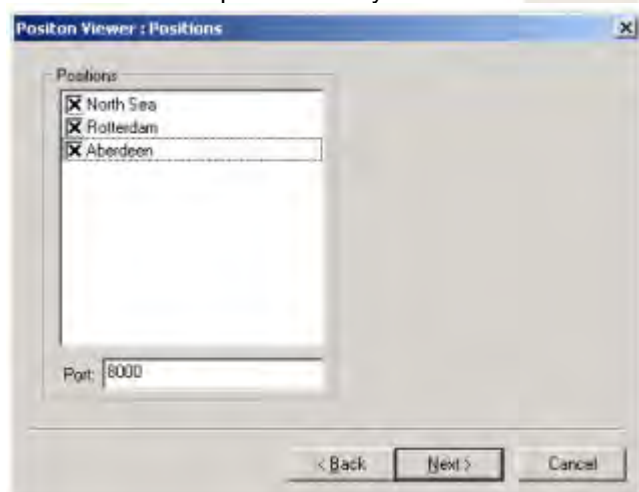

[\(More details about sockets\)](#).

### Position Viewer Glonass

Here the physical data port for the external input is defined. An NMEA GGA string from a Fugro 90964 is expected.

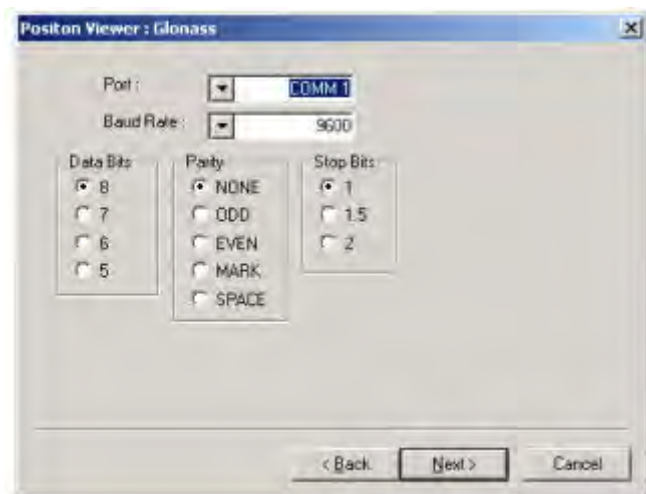

Alternative inputs can be set up within Position Viewer. See the Position Viewer manual for further details.

Click [Next>] to continue.

### Position Viewer DP

Enter the initial reference position for the DP Auto Selector.

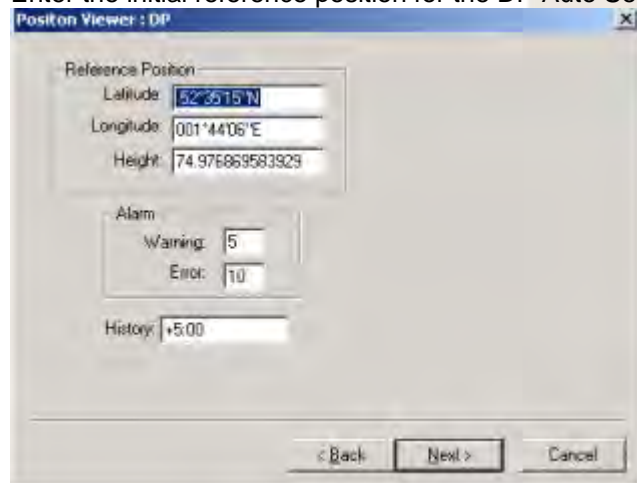

Set the alarm thresholds in metres and the "History", which is the period over which the stability will be determined. (see Position Viewer manual for more details).

Click [Next>] to continue.

### Output

Define the parameters for the port on which you wish to output the final position. By default this will be the DP Auto Select position.



Click [Finish] to complete the process. A copy of Position Viewer will then be started automatically with the defined configuration.

### 3.4.7.2. Save Almanac to File

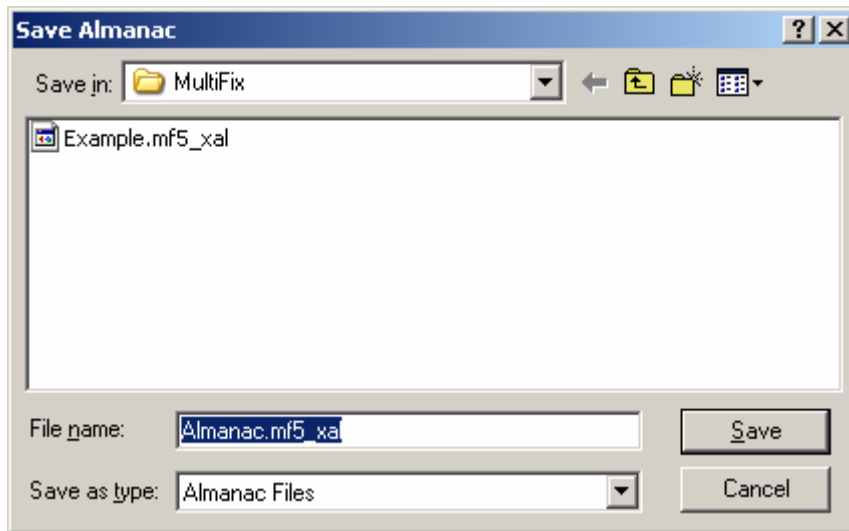

This option allows the user to save a copy of the **GPS** almanac (in Zero format) to an alternate location, such as a floppy disk.

The almanac can then be used in the GeoSky 2 application for GPS mission planning.

## 3.4.8. Windows

### 3.4.8.1. Tile

The tile command causes the application workspace to be reduced to the display area. The windows that are not minimised are fitted into the display area and the minimised windows are neatly stacked along the bottom of the screen

### 3.4.8.2. Close All

The close all command closes all windows irrespective of their status. As there is no confirmation required be careful not to use it in error.

### 3.4.8.3. The Open Windows

The "Window" drop down will also list all the windows currently open. Windows can be overlain one on top of another and it can be difficult to locate an obscured window. Clicking the window in the list causes the focus to shift to that window, the title bar is highlighted and it will appear on top of all the other windows. If there is

an extended application workspace, and the selected window is off screen, the display area will not move to show the window but the title bar of the window will still become highlighted.

If there are more than 9 windows open the bottom line of the menu will be "More Windows..." If this is selected a dialogue opens listing all windows. Highlight one of them and close the dialogue.

### 3.4.9. Help

Launches the online help.

#### 3.4.9.1. Performance

The Performance window shows how the program is handling the data acquisition and calculation process with the available resources. The window does not take into account other programs that are running simultaneously. The graphs will be green below 50%, yellow between 50% and 75% and red when above 75%.

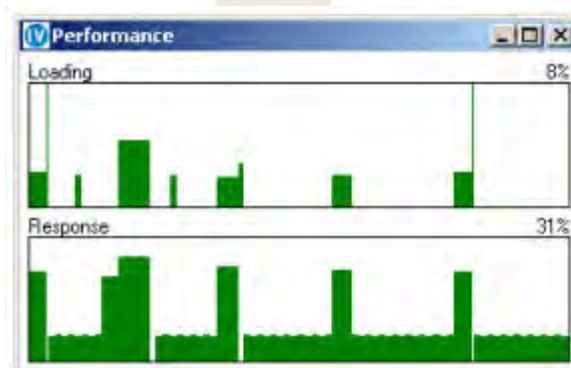

It is important there is enough time for all the processes to be completed in an orderly fashion. If there are too few resources the position solution may lag. The demand on the processor can be reduced by accessing only the data from the **RTCM** reference stations used in the computations, by having fewer computations and by closing windows.

The performance information can also be seen in the bar at the bottom of the application window next to the **UTC** Time.



### 3.4.9.2. About

This provides the version number and release date



### 3.4.9.3. Update/View License

Selecting this from the **Help** menu will launch the License dialog, showing information about the current licenses installed on the users PC.



This license information will also be displayed if the user attempts to launch MultiFix without there being a valid license installed on the machine. The field **Warning Days of License Expiry** is a user definable

number of days to check against the top level license. If the top level license is due to expiry within this user defined number of days, then this dialog will be launched, or updated, once day, warning the user. Also, if the top level license does actually expire, this dialog will be launched. Once a license has expired, any calculations relating to that license will be removed from the configuration. If all licenses have expired and become invalid, then trying to configure a new calculation will result in this dialog being launched until a license has been updated.

In order to add or update a license, the user clicks on the **Add/Update** button relevant to the type of license required. This launches the specific license dialog.

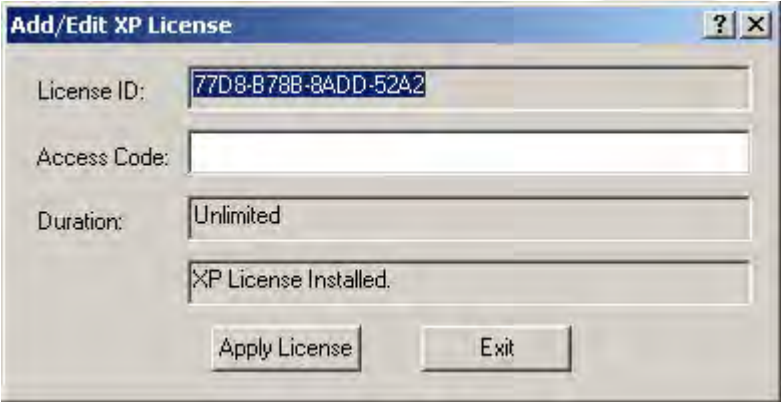

The screenshot shows a dialog box titled "Add/Edit XP License". It contains the following fields and controls:

- License ID:** 77D8-B78B-8ADD-52A2
- Access Code:** (empty)
- Duration:** Unlimited
- Message:** XP License Installed.
- Buttons:** Apply License, Exit

In order to obtain a specific license, the user needs to provide their local Opco with the code contained within the **License ID** field. The Opco can then give the user the corresponding code that needs to be entered into the **Access Code** field. Upon clicking **Apply License** a check is made to ensure the new license is valid. If the license is not valid, then a message will be displayed. No changes to the current licenses will result from this. If the license is valid, then it is stored on the users machine and the **Duration** field will be updated, along with message saying that the specific license has been installed.

Adding new licenses or old licenses expiring will be reflected the **Calculation Mode** tick boxes being enabled/disabled in [Calculation Settings](#).

## 3.5. MULTIFIX REPLAY

### 3.5.1. MultiFix Replay

When Raw Zero files have been logged it is possible to re-inject that same information into MultiFix by using the Replay option. Replay will read the Zero Log (\*.zer) files recorded by MultiFix and create outputs, which MultiFix can accept as source data. In Replay mode MultiFix performs re-computations in pseudo-real time. See [Zero logging](#).

To optimise the Replay operation not only must the Zero Log files be available but it is essential that the MultiFix configuration and other associated files are available as well.

To replay raw GPS and RTCM data in MultiFix first open the configuration file, which has been used for Zero logging. See [Open file](#).

Select the logged files that are to be replayed in “Logging” \ “Zero” \ “Edit” either by typing in the destination or by using the [Browse...] facility. This provides the Browse for Folder dialogue. The path can be defined by clicking on the desired destination folder. When selecting files of different days for replay the Zero files have to be consecutive.

MultiFix will recognise raw data input, thus any of the logging modes can be selected as long as the \*.zer files contain raw data. Positions are not accepted by MultiFix but they are by Qual 2 and Position Viewer. To replay position log files another Zero application, LOG PUMP has to be used. See Log Pump.

When the path and mode of logging have been selected click [OK]. See Log Pump Manual.

The Replay menu and toolbar buttons will only be visible if “Replay” has been enabled under the Options menu.

Be aware that the online operation mode will stop when entering Replay mode. The program provides a warning, clicking [OK] activates the new menu.

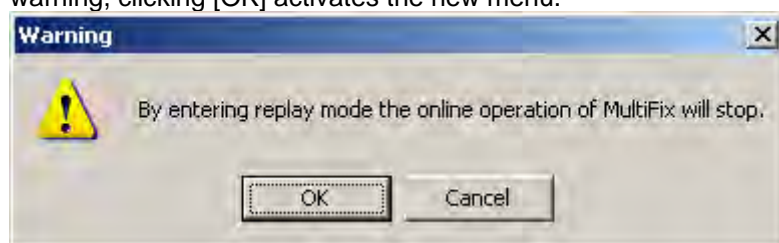

While in replay mode the GPS receiver type cannot be changed and new Starfix Decoder input cannot be defined. Evidently the selected GPS receiver cannot be configured from the Action menu.

The “View” \ “IO” \ “Status” window will only show output data as raw data is not being received via physical ports or sockets but from the replay application within MultiFix GPS Receiver input data will not be displayed in “View” \ “IO” \ “Scroller”, RTCM input and output strings however will be available.

In replay mode all other options and view windows will be available similarly to online operation. New calculations can be defined, as well as the calculation settings can be modified and new output strings can be generated. Even RINEX files can be logged in pseudo-real time.

See [Replay Options](#)

### 3.5.2. Replay options

Replay has 9 menu items, **Play**, **Stop**, **Pause**, **Fast Forward**, **Fast Rewind**, **Rewind**, **Step**, **Step Backward** and **Next File**. Each has a toolbar button equivalent.



**Play** starts the replay process and advances through the selected files with normal speed.



**Stop** resets the file reading to the start of the selected files.



**Pause** will arrest the replay process until another command is given.



**Fast Forward** will advance in replay with high speed.



**Fast Rewind** will advance backwards in the calculation with high speed.



**Rewind** will advance in the files backwards with normal speed.



**Step** will move the pseudo-real time calculation one step forward feeding the next epoch GPS data or RTCM correction into the filter.



**Step Backward** will move one step back in the calculation.



**Next File** will jump to the start of the next file. If replaying the last file “Next File” will jump to the end of the file.

The progress of the replay can be followed in “View” \ [Files](#)”.

By disabling “Replay” under the Options menu the online operation mode restarts.

## 4. APPENDICES

### 4.1. APPENDIX A - DATA OUTPUT STRINGS

#### 4.1.1. Appendix A - Data Output Strings

#### 4.1.2. NMEA GGA Sentence

```

111111111122222222223333333333444444444455555555556666666666777777777788
12345678901234567890123456789012345678901234567890123456789012345678901
$GPGGA,HHMMSS,DDMM.mmmmmmm,N,DDDMM.mmmmmmm,E,Q,NN,P.p,AA.aa,M,GG.gg,M,T.t,RFID*CS-^

```

where

\$	Start of Sentence Delimiter
GP	Talker Device Identifier
GGA	Sentence Formatter
,	Comma
HHMMSS <b>UTC</b>	Time of Fix, (up to 1 second old by time of output)
DDMM.mmmmmmm	Latitude at time of fix
N	Latitude Hemisphere Specifier, N or S
DDDMM.mmmmmmm	Longitude at time of fix
E	Longitude Hemisphere Specifier E or W
Q	<b>GPS Quality Indicator 0 = Fix invalid, 1 = non-diffGPS using C/A code, Fix valid,</b> 2 = DiffGPS using C/A code, Fix valid, 3 = GPS using P code, Fix valid
NN	Number of satellites used in Fix
P.p	<b>HDOP</b>
AA.aa	Antenna Altitude at time of fix with respect to <b>Geoid</b> (+ve Antenna above Geoid)
M	Height units, M = Metres
GG.gg	Geoid / Spheroid separation (+ve Geoid above WGS84 spheroid)
T.t	Time in seconds since last <b>RTCM</b> type 1 or type 9 message
RFID	Differential reference station ID, if a network it will be 1001, 1002, etc.
*CS	Checksum

␣	Carriage Return
␣	Line Feed

#### 4.1.3. GGA (LDA)

This is a modified version of the GGA string where the latency figure is divided by 5. This is for interfacing to equipment that will not allow a latency figure in excess of 10 seconds. By dividing the Latency, rather than fixing it, the system will still time out if a latency of 50 seconds is exceeded.

NB - This function should not be used on occasions that Selective Availability is enabled on the **GPS** system.

#### 4.1.4. GGA (SLV)

This is a modified version of the GGA string where the latency figure is divided by 6. This is for interfacing to equipment that will not allow a latency figure in excess of 10 seconds. By dividing the Latency, rather than fixing it, the system will still time out if a latency of 60 seconds is exceeded.

NB - This function should not be used on occasions that Selective Availability is enabled on the GPS system.

#### 4.1.5. NMEA GSA Sentence

```
111111111122222222223333333333
123456789012345678901234567890123456789
  |   |   |
$GPGSA,M,P,nn .. nn,p,p,h,h,v,v,*cs^
```

where

\$	Start of Sentence Delimiter
GP	Talker Device Identifier
GSA	Sentence Formatter
,	Comma
M	Mode M = Manual, forced to operate in 2D or 3D mode A = Automatic, allowed to automatically switch 2D/3D
P	Positioning mode indicator 1 = Fix not available, 2 = 2D, 3 = 3D
nn ..	ID numbers of satellites used in solution*

nn	
p.p	PDOP
h.h	HDOP
v.v	VDOP
*cs	Checksum
␣	Carriage Return
␣	Line Feed

\*Satellite ID numbers. To avoid possible confusion caused by repetition of satellite ID numbers when using multiple systems, the following convention has been adopted:

- a) GPS satellites 1 – 32
- b) Glonass 65 – 96

#### 4.1.6. NMEA GST Sentence

11111111112222222222333333333344444444445

12345678901234567890123456789012345678901234567890

| | |

\$GPGST,hhmmss.ss,r.r,s.s,d.d,o.o,l.l,m.m,a.a,\*cs^

where:

\$	Start of Sentence Delimiter
GP	Talker Device Identifier
GST	Sentence Formatter
,	Comma
HHMMSS.ss	UTC Time of Fix, (up to 1 second old by time of output)
r.r	RMS value of standard deviation of the range inputs to the navigation process
s.s	Standard deviation of semi-major axis of error ellipse (m)
d.d	Standard deviation of semi-minor axis of error ellipse (m)
o.o	Orientation of semi-major axis of error ellipse (degrees from True North)
l.l	Standard deviation of latitude error (m)
m.m	Standard deviation of longitude error (m)
a.a	Standard deviation of altitude error (m)

*cs	Checksum
␣	Carriage Return
␣	Line Feed

#### 4.1.7. NMEA GSV Sentence

##### NMEA GSV SENTENCE

```

111111111122222222223333333333444444444455555555
1234567890123456789012345678901234567890123456789012345678
  |           |           |           |
$GPGSV,n,m,tt,ss,ee,aaa,NN,.....,ss,ee,aaa,NN,*cs-␣
          SV1           SV2-3           SV4

```

where:

\$	Start of Sentence Delimiter
GP	Talker Device Identifier
GSV	Sentence Formatter
,	Comma
n	Total number of messages, 1 to 9 <sup>1</sup>
m	Message number, 1 to 9 <sup>1</sup>
tt	Total number of satellites in view
The following section is repeated for each satellite in view, to a maximum of 4 per string	
ss	Satellite ID number <sup>2</sup>
ee	Elevation, degrees, 90° maximum
aaa	Azimuth, degrees True, 000 to 359
NN	L1 SNR
*cs	Checksum
␣	Carriage Return
␣	Line Feed

<sup>1</sup> Satellite information may require the transmission of multiple messages all containing identical field formats. The first field specifies the total number of messages, minimum value 1. The second field identifies the order of this message (message number), minimum value 1.



<sup>2</sup> Satellite ID numbers. To avoid possible confusion caused by repetition of satellite ID numbers when using multiple systems, the following convention has been adopted:

- a) GPS satellites 1 – 32
- b) Glonass 65 - 96

#### 4.1.8. NMEA GSU Sentence

This is exactly the same as the [NMEA GSV Sentence](#), except after the 'NN' containing the L1 SNR there's now an extra field of the same size containing the L2 SNR value.

#### 4.1.9. NMEA VTG Sentence

```

1111111111222222222233333333
1234567890123456789012345678901234567
|           |           |
$GPVTG,CCC.c,T,,,SSS.s,N,VVV.v,K*cs-^

```

where:

\$	Start of Sentence Delimiter
GP	Talker Device Identifier
VTG	Sentence Formatter
,	Comma
CCC.c	Course Over Ground
T	True
SSS.s	Speed Over Ground
N	Knots
VVV.v	Speed Over Ground
K	Kilometres per Hour
*cs	Checksum
-	Carriage Return
^	Line Feed

The null fields would contain Course Over Ground Magnetic if MultiFix new anything about magnetic North.

#### 4.1.10.NMEA GLL Sentence

```

111111111122222222223333333333444444444455555
12345678901234567890123456789012345678901234
|           |           |           |           |
$GPGLL, DDMM.mmmmmmm, S, DDDMM.mmmmmmm, W, HHMMSS.ss, Q, M*cs-^

```

where:

\$	Start of Sentence Delimiter
GP	Talker Device Identifier
GLL	Sentence Formatter
,	Comma
DDMM.mmmmmmm	Latitude
S	Latitude Hemisphere N or S
DDDMM.mmmmmmm	Longitude
W	Longitude Hemisphere E or W
HHMMSS <b>UTC</b>	Time of the position
Q	Status Flag, A = Valid, V = Not Valid
M	Position System Mode Indicator (see note below) A = Stand Alone, D = Differential, E = Estimated, M = Manual Input, S = Simulated, N = Not valid
*cs	Checksum
-	Carriage Return
^	Line Feed

Note: - Between the **NMEA** 0183 Standard versions 2.01 and 2.30 the GLL sentence has had an extra field added after the Status Flag and before the checksum, this is called the Positioning System Mode Indicator.

The 2.30 Standard says that both the Status Flag and Positioning System Mode Indicator fields must not be null fields.

MultiFix complies with the 2.01 Standard and does not include the Position System Mode Indicator.

#### 4.1.11.RTK Sentence

Not to be used until Real Time Kinematic computations supported by the MultiFix.

#### 4.1.12.NMEA ZDA Sentence

```

111111111122222222223333333333
123456789012345678901234567890123456789
      |           |           |
$GPZDA, HHMMSS.ss, DD, MM, YYYY, ±hh, mm*cs-^

```

where:

\$	Start of Sentence Delimiter
GP	Talker Device Identifier
ZDA	Sentence Formatter
,	Comma
HHMMSS.ss	<b>UTC Time</b>
DD	Day in Month
MM	Month in Year
YYYY	Year
±hh	Local Time Zone hours offset, always zeroes
mm	Local Time Zone minutes offset, always zeroes
*cs	Checksum
-	Carriage Return
^	Line Feed

#### 4.1.13.NMEA RMC Sentence

```

1111111111222222222233333333334444444444555555555566666666667
123456789012345678901234567890123456789012345678901234567890
      |           |           |           |           |           |
$GPRMC, HHMMSS.ss, Q, DDMM.mmmmm, N, DDDMM.mmmmm, W, SS.s, CCC.c, DDMMYY, , *cs-^

```

where:

\$	Start of Sentence Delimiter
GP	Talker Device Identifier
<b>RMC</b>	Sentence Formatter
,	Comma
HHMMSS.ss	<b>UTC Time of fix</b>

Q	Status flag, A = valid, V = invalid
DDMM . mmmmm	Latitude
N	Latitude Hemisphere, North or South
DDDMM . mmmmm	Longitude
W	Longitude Hemisphere, East or West
SS . s	Speed Over ground in knots
CCC . c	Course Over Ground, True
DDMMYY	Date
*CS	Checksum
␣	Carriage Return
␣	Line Feed

The null fields refer to the Magnetic Variation

#### 4.1.14.NMEA UKOOA / IMCA DP Sentence

##### 4.1.14.1.NMEA UKOOA/IMCA DP Sentence

```

11111111112222222222333333333344444444445555555555666666666677777777778888
123456789012345678901234567890123456789012345678901234567890123456789012
$DPGGA,HHMMSS.SS,DDMM.mmmmm,N,DDDMM.mmmmm,E,Q,NN,P.P,AAA.aa,M,UGG.gg,M,T.t,DGPS*CS-^

```

where:

\$	Start of Sentence Delimiter
DP	Talker Device Identifier
GGA	Sentence Formatter
,	Comma
HHMMSS <b>UTC</b>	Time of Fix, (up to 1 second old by time of output)
DDMM . mmmmm	Latitude at time of fix
N	Latitude Hemisphere Specifier, N or S
DDDMM . mmmmm	Longitude at time of fix
E	Longitude Hemisphere Specifier E or W
Q	<b>DGPS Quality Indicator (see table below)</b>
NN	Number of satellites used in Fix
P . p	<b>HDOP</b>

U	Sign of Altitude above or below MSL/ <b>Geoid</b> .
AA . aa	Antenna Altitude at time of fix with respect to MSL/Geoid
M	Height units, M = Metres
U	Sign of Geoidal separation (+ve Geoid above WGS84 spheroid)
GG . gg	Geoid / Spheroid separation
T . t	Time in seconds since last <b>RTCM</b> type 1 or type 9 message
DGPS	DGPS system identifier, DGPR = DGPS Radio-Based Link, DPGI= DGPS Satellite -based link
*cs	Checksum
↵	Carriage Return
^	Line Feed

Notes – DGPS indicator is fixed to DPGI.

#### 4.1.14.2.DGPS Quality Indicator

<u>DQI</u>	<u>Status of Solution</u>	<u>Precision</u>	<u>Comment</u>
0	Failed solution	N/A	-
1	Uncorrected	N/A	Solution obtained but no differential
2	Corrected but no redundancy	N/A	Minimum DGPS Solution
3	Corrected Position; Redundancy of 1	Poor	Poor Dilution of Precision (DOP)/ Geometry
4	Corrected Position; Redundancy of 1	<10m	Adequate DOP / Geometry
5	Corrected Position; Redundancy > 1	<10m	Ability to reject Outlier; Gradual improvement in geometry/DOP
6	Corrected Position; Redundancy > 1	<10m	Ability to reject Outlier; Gradual improvement in geometry/DOP
7	Corrected Position; Redundancy > 1	<4m	Ability to reject Outlier; Gradual improvement in geometry/DOP
8	Corrected Position; Redundancy > 1	<2m	Ability to reject Outlier; Gradual improvement in geometry/DOP
9	Corrected Position; Redundancy > 1	<0.5m	Ability to reject Outlier; Gradual improvement in geometry/DOP



Q	Position Quality (0=Poor, 9=Good)
q	Differential Quality (0=No Corrections, 1=Poor.....9=Good)
mmss	Time Since Last Correction
N	Number of SV's Tracked
##	first SV <b>PRN</b>
SN	first SV <b>SNR</b> (Trimble Units)
RE	first SV Range Residual Error (m)
F	first SV Status Flag (Bit 0=Elevation Flag, 0=SV is above mask,
•	
•	##SNREF repeated for each SV
•	
nn	last SV PRN (This will be determined by the number of satellites being tracked)
nn	last SV SNR (Trimble Units)
nnn	last SV Range Residual Error (m)
n	last SV Status Flag
]	Stop Character
cs	Checksum (The hexadecimal representation of the modulo-256 sum of the characters from "[" to "]" inclusive
␣	Carriage Return
^	Line Feed

#### 4.1.16.DNAVN Nautis Modification

The Nautis Modified DNAV out put is in the same format to the standard DNAV, other than that a maximum number of satellites (10) are fixed within the output string. This allows a Nautis navigation system to accept DNAV strings that would normally contain 10 or more SVs.







^	Height Reference Indicator (S=Spheroidal Height, M=Height above MSL i.e. Orthometric)
M	Mode (H=Height Aided, 3=3D Solution, ?=Unknown)
XXx	95% Error Ellipse semi-major axis (m)
YYy	95% Error Ellipse semi-minor axis (m)
ZZZ	95% Error Ellipse Max Direction (°)
PPp	95% Latitude s d / Precision Value (m)
QQq	95% Longitude s d / Precision Value (m)
RRr	95% Height s d / Precision Value (m)
UUu	Unit Variance
F	F Test (P=Pass, F=Fail)
KKk	<b>HDOP (DD^D)</b>
LLl	<b>PDOP (DD^D)</b>
CCc	External Reliability (m) (Largest Position MDE at the Configured Level – typically 80%)
BB <b>LOP</b>	with External Reliability (SV <b>PRN</b> '01'-'99' or 'HT' if Altitude or '00' if computed but not used due to lack of redundancy)
NN	Number of SVs used at the Mobile N
nn . . . nn	Satellite PRN Numbers
TT	<b>W-Test rejected LOP (if any) (SV PRN '01' – '99', 'HT' if Altitude, '00' = OK)</b>
FF	Total Number of SVs used in Solution (Approximately = N x n for multi-reference station solution).
R n	Number of Reference Stations Used (0-9, 9 = 9 or more)
refstncds	The Codes of the Reference Station used. (Up to 9 three digit codes, first 9 if more than 9, if less than 9 padded with 0's))
optional	Optional additional data before checksum
cs	Checksum
↵	Carriage Return
^	Line Feed

#### 4.1.20.GECO UKOOA Output Format

```

11111111112222222222333333333344444444445555555555666666666677777777778888
123456789012345678901234567890123456789012345678901234567890123456789012
| | | | | | | | | | | | | | | | | | | | | | | | | | | | | | | | | | | | | | | | |
[0101NPMulti 1.32WWWTTTTTTTT.tAA.a_DD_MM.mmmmmN_DDD_MM.mmmmmEAAA.aHHH.hVVV.vUU.uuu

111111111111111111111111111111111111111111111111111111111111111111111111
8888888999999999990000000000111111111122222222223333333333444444
345678901234567890123456789012345678901234567890123456789012345678901234
| | | | | | | | | | | | | | | | | | | | | | | | | | | | | | | | | | | | | | | | |
XX.xxxYY.vyyZZ.zzz@@.@@@##.###FFSATREF SatNos RefStnIds ]-^

```

where:

[	Start Character
01	Record Identifier
01	Format Version
NP	Nav Point Number
_	Space
Multi 1.32	System Name/ Version (Should identify system and software version)
WWW	<b>GPS Week Number since January 6th 1980</b>
TTTTTTT.t	Seconds in GPS week (GPS time)
AA.a	Age of Fix
_DD_MM.mmmmm	Latitude
N	Latitude Hemisphere Identifier (N or S)
_DD_MM.mmmmm	Longitude
E	Longitude Hemisphere Identifier (E or W)
AAA.a	Spheroidal Height (above WGS 84)
HHH.h	<b>HDOP</b>
VVV.v	VDOP
UU.uuu	Unit Variance
XX.xxx	Variance Latitude
YY.yyy	Covariance Lat/Long
ZZ.zzz	Variance Longitude
@@.@@@	Variance Height



AAA . a	Spheroidal Height (above WGS 84)
HHH . h	<b>HDOP</b>
VVV . v	VDOP
UU . uuu	Unit Variance
XX . xxx	Variance Latitude
YY . yyy	Covariance Lat/Long
ZZ . zzz	Variance Longitude
@@ . @@@	Variance Height
## . ###	External Reliability
FF	Fix Status (Single Freq. 0=No or Bad Fix, 1=Alt. Aiding, 2=Alt Hold, 3=3D Fix) (Dual Freq. 4=No or Bad Fix, 5=Alt. Aiding, 6=Alt Hold, 7=3D Fix)
SAT	Number of Satellites Used
REF	Number of Reference Stations Used For This Fix
SatNos	<b>PRN Numbers of the satellites used in fix</b>
RefStnIds	ID's of the Reference Stations used in the fix
]	End Character
␣	Carriage Return
^	Line Feed

#### 4.1.22.Fugro XP Expanded Output Format

```

1111111111222222222233333333333344444444445555555555666666666677777777778
8888
1234567890123456789012345678901234567890123456789012345678901234567890
1234
|           |           |           |           |           |           |
**XHHMMSS.sDDMMYYAA.aDDMMSS.ssssNDDMMSS.ssssEHHHH.hhHHHH.hhNNN.nnEEE.eeC.ccccHH
H.hh
11111111111111111111
88888999999999990000000000111111
5678901234567890123456789012345

```



HHH . hh	95% Height s d / Precision Value (m)
XXX . xx	95% Error Ellipse semi-major axis (m)
YYY . yy	95% Error Ellipse semi-minor axis (m)
ZZZ	95% Error Ellipse Max Direction with respect to North (°)
LL . l	Latency (s)
HHH . h	HDOP (DDD^D)
PPP . p	PDOP (DDD^D)
M	Calculation Mode 0 – No Solution 1 – XP 2 – Dual Frequency Diff. 3D 3 – Dual Frequency Diff. 2D 4 – Single Frequency Diff. 3D 5 – Single Frequency Diff. 2D 6 - Standalone
M	XP Mode 0 – No Solution 1 – XP 2 – Converging to XP 3 – Backup Solution 1 4 – Single Frequency Diff. 3D 5 – Single Frequency Diff. 2D 6 – Standalone

**DIFFERENTIAL ONLY – this section is only generated if a standard differential calculation is used, either as a standard calculation or an XP back-up (i.e. XP Mode = 2, 3, 4, 5 or 6)**

UU . uu	Unit Variance
F	F Test (P=Pass, F=Fail)
RR . rrrr	External Reliability (m) (Largest Position MDE at the Configured Level – typically 80%)
BB	PRN with highest External Reliability value
NN	Number of SVs used in the calculation

nn .. ..	Satellite PRN Numbers
nn	
RR	Number of Reference Stations Used (0-99)
CC	Number of Reference Stations in Configuration (0-99)
iii	The ID Code of Reference Station 1. (three digit code)
X	Number of SVs from Reference Station 1. (hexadecimal character)
iii	The ID Code of Reference Station n. (three digit code)
X	Number of SVs from Reference Station n. (hexadecimal character)
*XX	Checksum
↵	Carriage Return
^	Line Feed

**XP ONLY - this section is only generated if a true XP calculation is used (i.e. XP Mode = 0 or 1)**

UU.uu	Unit Variance, delta calculation
F	F Test (P=Pass, F=Fail), delta calculation
RR.rrrr	External Reliability (m) (Largest Position MDE at the Configured Level – typically 80%), delta calculation
BB	PRN with highest External Reliability value
NN	Number of SVs used in the delta calculation
nn .. ..	Satellite PRN Numbers in the delta calculation
nn	
UU.uu	Unit Variance, filter calculation
I	Innovation Check (P=Pass, F=Fail), filter calculation
RR.rrrr	External Reliability (m) (Largest Position MDE at the Configured Level - typically 80%), filter calculation
BB	PRN with highest External Reliability value
NN	Number of SVs used in the filter calculation
nn .. ..	Satellite PRN Numbers in the filter calculation
nn	
iii	XP StarFix Beam ID
*XX	Checksum
↵	Carriage Return





YYY.yy	95% Error Ellipse semi-minor axis (m)
ZZZ	95% Error Ellipse Max Direction with respect to North (°)
UU.uu	Unit Variance, filter calculation
F	F-Test for Backup solution or Innovation Check for XP solution (P=Pass, F=Fail)
RR.rrrr	External Reliability (m) (Largest Position MDE at the Configured Level - typically 80%), filter calculation
LL.l	Latency (s)
HHH.h	HDOP (DDD^D)
PPP.p	PDOP (DDD^D)
NN	Number of SVs used in the calculation
M	<p>Calculation Mode</p> <p>0 – No Solution</p> <p>1 – XP</p> <p>2 – Dual Frequency Diff. 3D</p> <p>3 – Dual Frequency Diff. 2D</p> <p>4 – Single Frequency Diff. 3D</p> <p>5 – Single Frequency Diff. 2D</p> <p>6 - Standalone</p>
M	<p>XP Mode</p> <p>0 – No Solution</p> <p>1 – XP</p> <p>2 – Converging to XP</p> <p>3 – Backup Solution 1</p> <p>4 – Converging to Backup Solution 1</p> <p>5 – Backup Solution 2</p> <p>6 – Converging to Backup Solution 2</p>
RR	Number of Reference Stations Used (0-99)
*XX	Checksum
↵	Carriage Return
^	Line Feed

#### 4.1.24.Fugro Corrections

\$PFIL,CORR,nm,im,sm,nrs,as,ncs,csn,csm,nrscs,cs,CR,LF

where,

\$PFIL,CORR	Message Identifier
nm	Number of Messages ( <b>Integer</b> )
im	Current Message Index ( <b>Integer</b> )
sm	Solution Mode (" <b>Standalone</b> ", " <b>DGPS</b> " or " <b>XP</b> ")
nrs	Number of Reference Stations in current solution ( <b>Integer</b> )
as	Active Source for XP Corrections ( <b>String</b> )
ncs	Number of Correction Sources configured ( <b>Integer</b> )
The following section is repeated for each Correction Source configured, to a maximum of 2 per string	
csn	Correction Source Name ( <b>String</b> )
csm	Correction Source Mode (" <b>Unknown</b> ", " <b>DGPS</b> ", or " <b>XP</b> ")
nrscs	Number of Reference Stations selected from Correction Source ( <b>Integer</b> )
cs	Checksum
CR	Carriage return
LF	Line Feed

## 4.1.25.UTM / SYLEDIS

```

          11111111112222222222333333333334
1234567890123456789012345678901234567890
          |           |           |           |
Y±NNNNNNNN.n X±EEEEEEE.e Ffff Qggggggg↵^

```

where

<u> </u> .....	Space
<u>Y</u> .....	Y co-ordinate Identifier
<u>±NNNNNNNN.n</u> .....	Northings to 0.1 of a metre
<u>X</u> .....	X co-ordinate Identifier
<u>±EEEEEEE.e</u> .....	Eastings to 0.1 of a metre
<u>F</u> .....	Differential Flag Identifier
<u>fff</u> .....	000 = Diff Corrected, 001 = Stand Alone
<u>Q</u> .....	Quality Flag Identifier
<u>gggggggg</u> .....	Not Implemented, always 0000000
<u>↵</u> .....	Carriage Return
<u>^</u> .....	Line Feed

The Eastings and Northings will be Transverse Mercator co-ordinates, the projection grid is defined when setting up the output.

#### 4.1.26.UTM / GEM 80P

```

1111111111222222222233333333
123456789012345678901234567890123456
|           |           |
Y±NNNNNNN.n X±EEEEEEE.e Q qDRMLPM↵^

```

where

<u>  </u>	Space, ASCII character 32
<u>Y</u>	Y co-ordinate identifier, (ASCII character 89)
<u>±</u>	Sign + or -
<u>NNNNNNN.n</u>	Northings (leading zeros when necessary)
<u>X</u>	X co-ordinate identifier, (ASCII character 88)
<u>EEEEEEE.e</u>	Eastings (leading zeros when necessary)
<u>Q</u>	Quality Field Identifier
<u>q</u>	Quality : Filtering Strictness n
<u>DRM</u>	Quality :DRMS (metres) <u>nnn</u>
<u>LPM</u>	Quality :LPME (metres) <u>nnn</u>
<u>↵</u>	Carriage Return
<u>^</u>	Line Feed

The Eastings and Northings will be Transverse Mercator co-ordinates, the projection grid is defined when setting up the output.

#### 4.1.27.NMEA GSV Sentence

This is exactly the same as the [NMEA GSV Sentence](#), except after the 'NN' containing the L1 SNR there's now an extra field of the same size containing the L2 SNR value.

#### 4.1.28.DGPS-IS

This output is under development and not fully implemented.

## 4.2. APPENDIX B - UNDERSTANDING SCINTILLATION

### 4.2.1. Appendix B - Understanding Scintillation

Recent increases in the level of solar activity have had noticeable effects on **GPS** receiver equipment.

Effects can be categorised into two distinct effects:

- a. Ionospheric delay
- b. Scintillation

**Ionospheric Delay** is sometimes called the gradient effect. It is caused by the GPS signal slowing as it passes through the ionosphere. The signals are slowed at different rates at different locations, depending on the path taken through the earth's atmosphere. When a DGPS system is in use, the path of the signal through the atmosphere from the individual satellites will be different to the reference station and to the user. Therefore, standard pseudorange corrections, that only model the atmospheric differences, may not fully remove the range error.

This error is removed by using dual frequency observations, such as with **SkyFix premier**. The second frequency allows the magnitude of the delay to be measured at both the reference station and the users location. The error can then be removed.

**Scintillation** is a different phenomenon. The GPS signal is itself damaged in the ionosphere leading to failure of the GPS receiver to maintain a lock on the satellite. This same problem can occur to the satellite based **RTCM** delivery links, be they SPOT or Inmarsat, as discussed later.

The net effect is that instabilities are introduced into the position calculation, potentially each time a satellite is removed or reintroduced into the solution. This is best illustrated by looking at an example.

In the MultiFix screen shot on the right (taken from "View" \ "Calculation" "Residuals" the individual lines of position from each SV can be visualised in 2D. The users position is derived by a weighted least squares adjustment to fit within all the lines of position. This is in the centre of the display and is marked by the letter A.

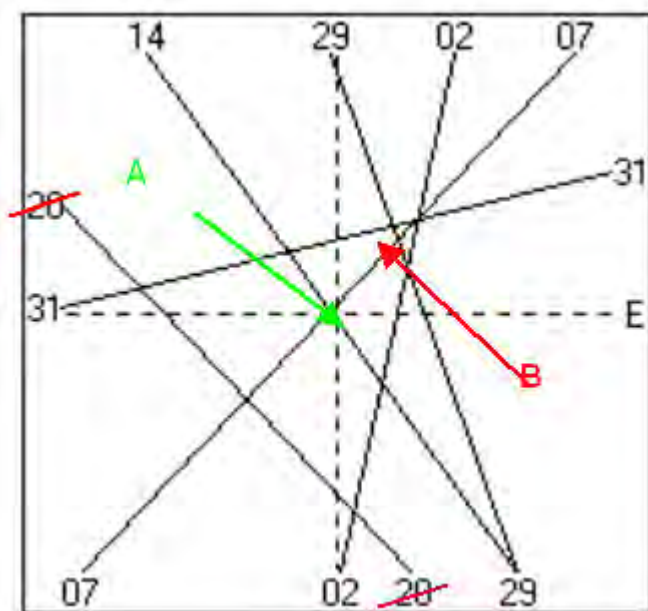

Now, consider a scenario where SV 20 is suddenly removed from the calculation. The correct solution for a least squares adjustment is then close to point B.

The size of the resulting position jump is obviously dependant on both the size of the “cocked hat” (and resulting error ellipse) and the effect of the missing SV on that cocked hat. There are many factors to consider when reviewing the residuals including but not restricted to:

- Number of SVs in view,
- Geometry of SVs
- Elevation of individual SVs

During periods of high ionospheric activity this cocked hat will be large (the solution will be divergent) due to ionospheric delay, the effects will therefore be greater. This effect will be reduced if dual frequency observations are used, as the cocked hat will once again be small.

We have seen here the potential effect of scintillation on a single SV. In reality, scintillation will affect more than one SV at a time, although it rarely affects all SVs at the same time. With the removal of each SV, the stability of the solution is reduced, thereby increasing the effect of subsequent satellite losses.

## 4.2.2. Detecting Scintillation

Ionospheric conditions are at their worst around the geomagnetic equator. Therefore, if you are in the Southern Hemisphere satellites to the North are the most likely to be affected, conversely in the Northern Hemisphere satellites to the South are most effected. If you are close to the equator all satellites may be affected.

There are a number of ways of detecting scintillation within MultiFix. The first sign is within the Signal to Noise Ratios (**SNR**). These can be viewed in MultiFix under "View" \ "GPS" \ "Measurements". High variations in SNR are indicative of scintillation. Note you will also see low fluctuating SNRs with low elevation satellites or other forms of interference.

The screen shot below is of SNRs under normal conditions. The scale bar on each measurement is the variation over the past 100 records.

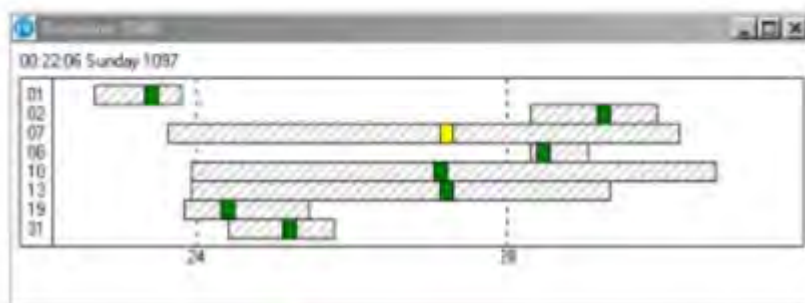
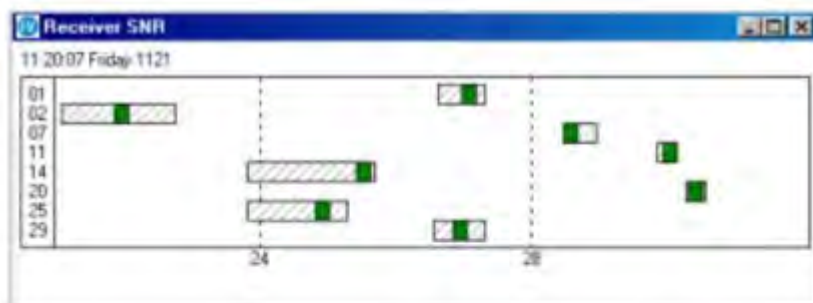

This second plot is taken from a period of scintillation and demonstrates the scale of the variation typically seen.

A more graphical indication of the effect of scintillation can be found in the Time series Code Carrier Filter (**CCF**).



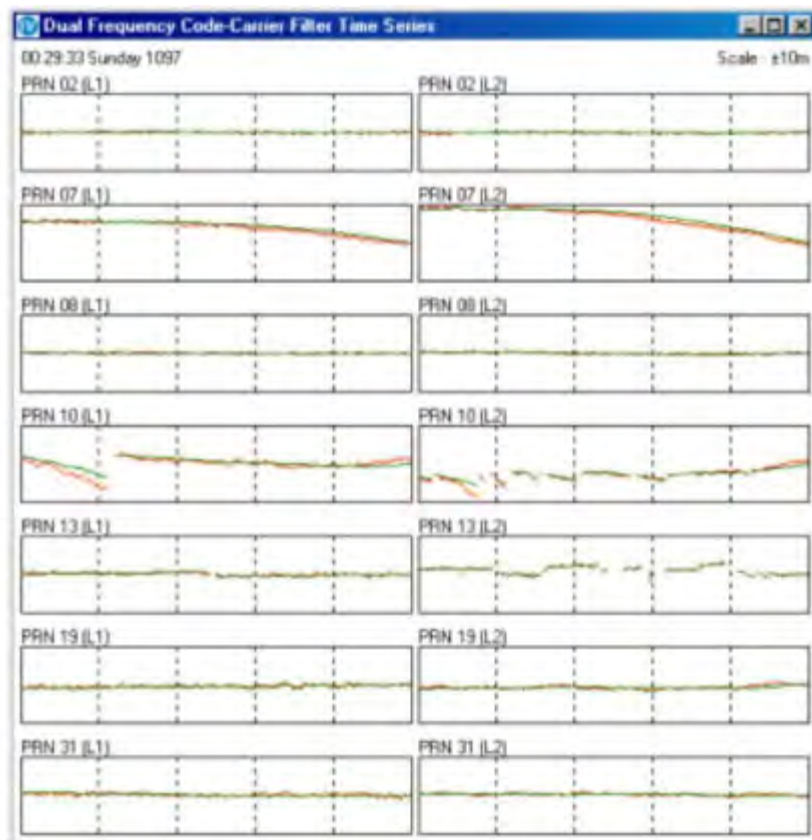

In this display the tracking of the individual SVs in both **L1** and **L2** can be visually monitored. In the following screen shot there are interruptions, caused by scintillation on **PRN 13** (L2 only) and PRN 10 (L1 and L2).

These breaks in data can cause the position jumps that make scintillation such a problem. As you can see the breaks are not continuous, the satellite repeatedly drops in and out. This continuous change is what creates the repeated position instabilities, making the solution unusable.

### 4.2.3. Combating Scintillation

MultiFix contains a scintillation meter and filter facility. The displays, detects and helps to remove the effects of scintillation.

This scintillation meter summarises which satellites are being interrupted. By enabling the Scintillation filter, the satellites that are frequently interrupted will be removed from the calculation until they have stabilised again. This gives a significant improvement in performance, although users need to be aware that it will result in a reduced number of satellites.

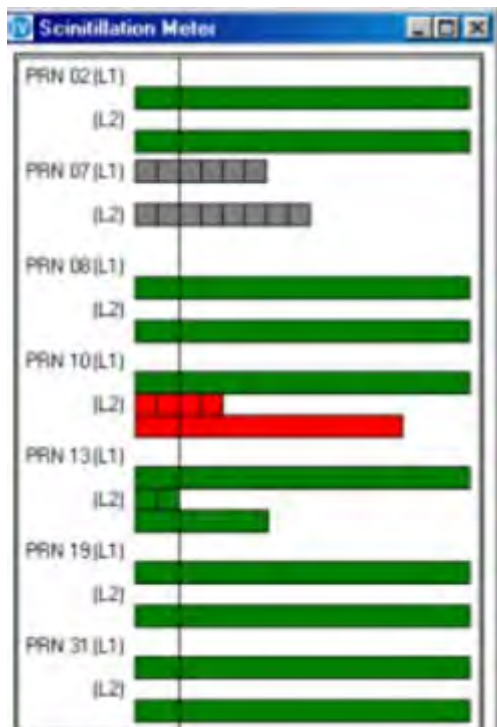

It is therefore recommended to work in height aiding mode when using the scintillation meter.

For more details see ['Scintillation Filter'](#), and ['Scintillation Meter'](#).

#### 4.2.4. Scintillation of the Data Links

Scintillation can also affect the continuity of the *DGPS* satellite link signals, both Inmarsat and SPOT.

MultiFix includes the option to display the quality of the StarFix decoder signals, as below, see MultiFix Section for further details.

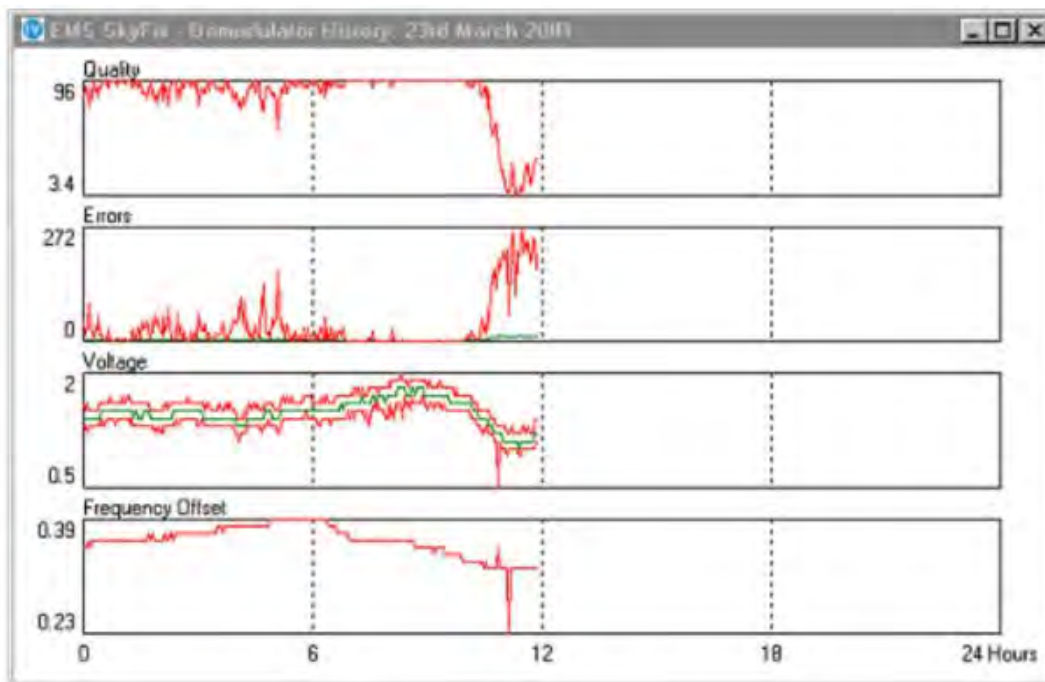

The Demodulator History display, found under “View” \ “Corrections” \ “StarFix Decoder” \ “History” provides an illustrative summary of the stability of the StarFix signal as recorded by the decoder. During scintillation one may see that the “Quality” drops, that the “Errors” increase and that the Minimum and Maximum “Voltage” separation widens.

A more detailed description of the [Demodulator History view](#).

### 4.3. APPENDIX C - STATIC POSITION OFFSET FILE

Where **RxV** is to be used in a static environment, or for training purposes, the PDS module is not required. Instead, the fixed antenna locations can be entered into an XML file, as below.

Each Location requires a unique “Point ID”. The ID is defined within RxV under config\calculation\Receivers...”. Each receiver requires a unique ID, additional IDS can be defined for the location of the virtual antenna, for the output.

The name is for reference purposes and is shown on the “Rx SV Status” window in brackets.

Latitude, Longitude and height are used to define the point location.

An example XML file is given below. User defined text is marked in black.

```
- <Vessel>
  <Name>Vessel Name</Name>
  = <Point ID="31">
    <Name>Mast head</Name>
    <Latitude>52° 36' 10.25692" N</Latitude>
    <Longitude>1° 17' 04.49008" E</Longitude>
    <Height>76.036</Height>
  </Point>
  = <Point ID="32">
    <Name>Helideck</Name>
    <Latitude>52° 36' 10.25505" N</Latitude>
    <Longitude>1° 17' 04.45858" E</Longitude>
    <Height>75.890</Height>
  </Point>
  = <Point ID="33">
    <Name>Stbd Crane</Name>
    <Latitude>52° 36' 10.16859" N</Latitude>
    <Longitude>1° 17' 04.17211" E</Longitude>
    <Height>75.825</Height>
  </Point>
  = <Point ID="40">
    <Name>Virtual antenna</Name>
    <Latitude>52° 36' 10.00" N</Latitude>
    <Longitude>1° 17' 04.00" E</Longitude>
    <Height>70.00</Height>
  </Point>
</Vessel>
```

---

## 5. GLOSSARY

### A

**Almanac:** The purpose of an almanac is to provide rough estimations of satellite locations. All GPS satellites transmit almanac data. It includes orbital information of all the space vehicles clock corrections and atmospheric delay parameters. The orbit information is a subset of the Ephemeris data with reduced accuracy.

### B

**BD750:** A Trimble 750 GPS receiver mounted on a board

**BER:** Bit Error Rate

### C

**Carrier Phase Count:** An incremental count of wave lengths

**CCF:** Code Carrier Filter

**Code/Carrier Measurements:** Observations put into the Code/Carrier Filter

**COM Port:** Communications Port

**Constellation:** The locations of all the satellites (and other celestial bodies) at a given moment in time, usually expressed with respect to a terrestrial observer

### D

**DGPS:** Differential GPS

**Digiboard:** Board containing multiple serial I/O ports

**Double Differences:** A technique used to remove the effects of different receiver clocks

### E

**EGM96:** Earth Gravitational Model 1996

**Ephemeris:** The accurate positions of celestial objects as a function of time.

### F

**F-Test:** A single test on a solution to determine if the residuals are of the expected magnitude.

### G

**Geoid:** The particular equipotential surface, which coincides with Mean Sea Level and which may be imagined to extend through the continents. This surface is everywhere perpendicular to the force of gravity.

**GPS:** Global Positioning System

## H

**HDOP:** Horizontal Dilution of Position - a statement of the strength of the horizontal geometry of the constellation.

## I

**IMCA:** International Marine Contractors Association

**IOD:** Issue of Data Ephemeris - a number used to identify a particular Ephemeris

## L

**L1:** a frequency of 1575.42MHz and therefore in vacuo wavelength of approximately 19cm

**L2:** a has frequency of 1227.60MHz and therefore in vacuo wavelength of approximately 24cm

**LAN:** Local Area Network

**LOCI:** The Loss of Continuity Indicator will show True when the reference station of a satellite is not continuous.

**LOP:** Lines of Precision

## M

**Multipath:** The effect of a reflected signal interfering with the direct signal

## N

**NMEA:** National Marine Electronics Association

## P

**PDOP:** Position Dilution of Position - a 3D statement of the strength of the geometry of the constellation.

**PRN:** Pseudo Random Noise

## R

**RINEX:** Receiver Independent Exchange format

**RMC:** Recommended Minimum Specific GPS/Transit Data

**RMS:** Root Mean Square

**RTCM:** Radio Technical Commission for Maritime Services

**RTK:** Real Time Kinematic - the use of carrier phase measurement and wavelength integer ambiguity resolution

**RxV:** Receiver Verify (A Zero Suite Application)

## S

**SD:** Standard Deviation

**SkyFix Premier:** Dual frequency positioning mode within MultiFix

**SkyFix XP:** High accuracy positioning mode within MultiFix

**SNR:** Signal to Noise Ratio - A measure of signal strength over ambient noise

**SV's:** Space Vehicles (Satellites)

## T

**TCP/IP:** Transmission Control Protocol / Internet Protocol

**TSIP:** Trimble Standard Interface Protocol

## U

**UDP:** User Datagram Protocol

**UKOOA:** UK Offshore Operators Association

**UTC:** Universal Time Constant

**UTM:** Universal Transverse Mercator (Projection)

## W

**W-test:** A test on an individual measurement to determine if it has a significant bias.

## Z

**ZeroLink:** Communication format between applications in the Zero Suite

**Zpo:** Zero position output file

Index

**A**

About.....	160
Advanced Receiver Configuration .....	96
Advanced TSIP Configuration.....	89
Advanced_TSIP_Configuration .....	93
Almanac.....	15, 91, 158
Antenna Altitude.....	164
Appendix.....	164
Appendix B.....	189
Appendix C .....	194
Ashtec G12 .....	25
Ashtech.....	21, 23, 24, 25, 26
Ashtech DG16 GPS.....	16
Ashtech Evaluate.....	21
Ashtech Evaluate Configuration .....	21
Ashtech Z-Family.....	23

**B**

Baud Rate.....	20
BD112.....	27, 28, 67
BD750.....	32, 67, 106
Bit Error Rate.....	69, 127
Brunei.....	8
Brunei Shell VTS.....	8
Bullseye .....	129

**C**

Client.....	63
Client PC.....	63
Clock.....	118
Clock window.....	106
Close All.....	158
Code Carrier Filter .....	114, 191
Collect Almanac.....	91
Colour .....	130, 151
Comm .....	61
Comms Profile .....	12
Computer.....	63, 65
Configuration.....	20
Configure TSIP .....	67
Constellation .....	129, 151
Course Over Ground.....	168
Course Over Ground Magnetic.....	168
Covariance Lat/Long.....	179
Creating Icons.....	9

**D**

Data Ephemeris .....	121
Data Links .....	193
DATA OUTPUT STRINGS.....	12, 164
Data Table.....	121
datagram.....	102
Datagrams.....	102
Decoder.....	69
Default Receiver Configuration .....	96
Default TSIP Configuration .....	93
Deleting.....	81
Demodulator History .....	193
DG16.....	24, 67
DGPS.....	123, 172, 189
DGPS Data .....	123
DGPS Quality Indicator.....	164, 172
DGPS-IS .....	12, 164, 188
DIGIBOARD DRIVERS.....	9
DNav .....	12, 174
DNAVN.....	164, 173, 174
DNAVN Nautis Modification .....	174
DNAVN Output Format .....	173
Dongle.....	8, 9
Dongle Database .....	8
Dongle Drivers .....	9
DOP .....	134
DSM.....	28
DSM212 .....	67
Dual Frequency.....	17

**E**

Earth Gravitational Model 1996.....	15, 136
Edit Header .....	59
EGM96.....	136
Elevation Mask.....	35, 37
Enable MultiFix.....	35
Ephemeris.....	115, 121
equipotential.....	136, 164
Event Log.....	149
Event Logger.....	153
Exit.....	55

**F**

Files.....	49, 99, 158
Fix .....	179
Format Version.....	179
Front Panel Configuration .....	29
F-test.....	141
Fugro UKOOA Output Format.....	176



Fugro XP Concise Output Format ..... 184  
 Fugro XP Expanded Output Format ..... 180  
 Fugro\_TGS 90964 ..... 67  
 Fugro\_TGS 90964 GLONASS ..... 154

**G**

G12 ..... 25, 67  
 Geco UKOOA ..... 12, 82, 164, 179  
 GECO UKOOA Output Format ..... 178  
 GECO UKOOA Version ..... 179  
 GEM 80 DP ..... 12  
 GEM 80P ..... 188  
 Genesis ..... 32  
 Geoid ..... 136  
 GeoSky ..... 158  
 GeoSky II ..... 8  
 GG24 ..... 26, 67  
 GGA ..... 164, 165  
 GLL ..... 169  
 GLL Sentence ..... 169  
 Global Positioning System ..... 189  
 GPS Receiver ..... 67  
 GPS Week Number ..... 179

**H**

HDOP ..... 134, 164, 173, 179  
 Height Aiding ..... 67, 141  
 Hide Tool Bar ..... 152  
 History ..... 128  
 Horizontal Component of Velocity ..... 175  
 Horizontal Dilution of Position ..... 134, 164, 171, 173, 179

**I**

IDS ..... 194  
 IMCA DP SENTENCE ..... 164  
 Introduction ..... 15  
 IODE ..... 120  
 Iono ..... 69  
 Iono Filter ..... 114  
 ionodelay ..... 8  
 Iono-free ..... 8  
 Iono-Free DGPS ..... 15, 79  
 Ionospheric ..... 69  
 IP 63  
 Issue of Ephemeris ..... 123

**K**

Kalman Filter ..... 93  
 Klobachar ..... 123

Klobachar Ionospheric ..... 15, 79

**L**

L1 39, 106, 107, 111, 129  
 L2 39, 106, 107, 111, 129  
 Latency ..... 130, 151, 165  
 Latitude Hemisphere Indicator ..... 175  
 Latitude Hemisphere N ..... 169  
 Latitude Hemisphere Specifier ..... 164, 173  
 LDA ..... 164, 165  
 Lines Of Precision ..... 139  
 Lock ..... 151  
 Logging Schedule ..... 49  
 LOGPUMP ..... 8, 9, 57  
 Longitude Hemisphere E ..... 169  
 Longitude Hemisphere Indicator ..... 175  
 Longitude Hemisphere Specifier ..... 173  
 Longitude Hemisphere Specifier E ..... 164  
 LOP ..... 139  
 LRTK application ..... 8

**M**

Mean Sea Level ..... 15, 136, 164, 171  
 Measurements ..... 106  
 MF4\_G12.gps ..... 25  
 MS 750 ..... 29, 106  
 MS750 ..... 32, 67  
 MultiFix ..... 15, 31, 49, 63, 65, 162  
 Multipath ..... 106, 113

**N**

National Marine Electronics Association ..... 29, 88, 169  
 Nautis ..... 174  
 NAUTIS MODIFICATION ..... 164  
 Nautis Modified DNAV ..... 174  
 New ..... 69  
 New Calculation ..... 79  
 NMEA.. 12, 29, 84, 88, 154, 164, 165, 166, 167, 168, 169, 170, 171, 188  
 NMEA GGA ..... 154, 164  
 NMEA GGA Sentence ..... 164  
 NMEA GLL SENTENCE ..... 164  
 NMEA GSA Sentence ..... 165  
 NMEA GST Sentence ..... 166  
 NMEA GSU Sentence ..... 168, 188  
 NMEA GSV Sentence ..... 167  
 NMEA RMC SENTENCE ..... 164  
 NMEA UKOOA ..... 164

NMEA UKOOA/IMCA DP Sentence .....	171	Receiver .....	106
NMEA VTG SENTENCE.....	164, 168	Receiver Clock Frequency Offset .....	175
NMEA ZDA .....	164, 170	Receiver Code .....	173
NMEA ZDA Sentence .....	170	Receiver Cycle Outputs .....	37
Normalised Residual.....	141	Receiver Dynamics .....	173
NovAtel .....	42, 45, 46, 48, 67	Receiver Independent Exchange .....	153
NovAtel Millennium .....	42, 45	Reference Location file .....	49
NovAtel Millennium for MultiFix.....	45	Reference Station .....	69, 130
NovAtel Millennium OEM.....	42	Remote Configuraton .....	31
NovAtel Millennium OEM Card .....	42	Replay .....	162
NovAtel Millennium to COM.....	42	Replay options .....	163
NovAtel OEM4 Card .....	46	Requirements.....	18
<b>O</b>		Reset.....	93
OEM4.....	48	Residual .....	139, 141
Offsets.....	137	Rinex .....	153
Open .....	53	RMC.....	84, 170
Open Windows.....	158	RMC Sentence.....	170
Orbit Data.....	120	RMS .....	139
Output .....	12	RTCM.....	8, 15, 104, 132, 139, 159
Output Format.....	179	RTCM Corrections .....	39
Output Pre-Selection.....	12	RTCM Input.....	104
Output Strings.....	105	RTCM Performance window .....	124
<b>P</b>		RTCM Type.....	130
P2/94 Output.....	89	RTCM Type 16.....	132
Pausing.....	57	RTK.....	169
PC Port COM1 .....	42	RTK SENTENCE .....	164, 169
PDOP.....	29, 134, 173, 175	Run MultiFix .....	51
PDS.....	194	RxV .....	67
Performance .....	159	<b>S</b>	
Persistence file.....	49	Save .....	158
Position Dilution of Position .....	29, 134, 173, 175	Scintillation.....	107, 191, 192, 193
Position Viewer .....	154	Scintillation Filter .....	67
Position Viewer Wizard .....	154	Scintillation Meter.....	107
Positions .....	136	Scintillation of the Data Links .....	193
POSITIONVIEW.....	9	Selective Availability.....	165
Premier .....	17	Sentence Delimiter.....	164, 169, 171
PRN .....	175, 178, 179	Sentence Formatter .....	164, 169, 171
Pseudo Random Noise .....	173, 175, 178, 191	SERIAL PORT OUTPUT.....	31
<b>Q</b>		Server.....	63, 65
Qual .....	8	Server PC.....	63
<b>R</b>		Settings .....	74
Radio Technical Commission for Maritime Services 15, 18, 69, 124, 139, 149, 164, 171		Signal to Noise Ratios.....	191
Raw Code Carrier .....	109	Signal Voltage.....	69
Real Time Kinematic.....	12, 169	SK8 .....	28, 67
		SkyFix Premier.....	15, 18
		SkyFix Single Frequency .....	16

SkyFix XP .....	15, 17, 69, 77, 93, 137
SkyFix XP Filter .....	93
SkyLink .....	8
SkyNet Monitor .....	8
SLV .....	165
SNR .....	113, 191
SNR Weight .....	113
Speed Over Ground.....	173
Spheroid.....	136
SSE.....	37
SSi .....	39
Standard Deviation .....	137
Standard Deviation of the Code Carrier Filter.....	109
Standard Deviation of the Innovation.....	109
Standard Outputs.....	82
Starfix.....	15, 16, 17, 77, 93, 133
Starfix Beams.....	133
Static Position Offset File.....	194
Station Identification Number.....	175
Status.....	97
Status Flag.....	169
Stop Bits.....	61
Stopping.....	57
Summary.....	114
SV .....	67, 91, 97, 115, 129
SV Status.....	97
SVs .....	174, 191
SYLEDIS.....	164, 187
Synchronise Measurements .....	93
<b>T</b>	
Table.....	127
Talker Device Identifier .....	164, 168, 169
TCP.....	63, 65
TCP Client.....	63
TCP/IP .....	91
Tile .....	158
Time of Fix .....	173
Time Series.....	120, 144
Time Series Plots.....	144
Time Since Last Correction.....	173
Time Tag.....	29
Tool Bar .....	51
Transport Control Protocol.....	66
Trial Point.....	49, 152
Trial Point Warning .....	152
Trimble.....	12, 27, 28, 32, 35, 37, 39
Trimble 4000DS.....	35
Trimble 750 GPS.....	32, 67, 106
Trimble BD750.....	32
Trimble DSM.....	28
Trimble DSM2 12.....	28
Trimble MS750.....	17
TRIMBLE Output Format .....	164, 175
Trimble SK8 .....	28
Trimble Standard Interface Protocol .....	27, 28
TSIP .....	27, 28
TSIP Break.....	27
TSIP Talker .....	27
Type 15 .....	15, 124, 130
Type 15/55.....	124, 130
Type 16.....	49, 132, 153
Type 16 Alert.....	153
Type 55 .....	79
<b>U</b>	
UK Offshore Operators Association.....	12, 15, 82, 139
UKOOA .....	139, 141, 176, 178, 179
UKOOA recommendations.....	15
UKOOA Stats .....	141
Understanding Scintillation.....	107, 189
Unit Variance.....	134, 139, 141
Updating Registry Information.....	9
User Datagram Protocol.....	66
User Modified NMEA Sentences.....	84
UTC Time.....	159
UTC Time of Record .....	173
UTM .....	12, 88, 164, 187, 188
UTM Outputs.....	88
UTM/GEM 80 DP .....	164
<b>V</b>	
vacuo.....	37, 191
Variance Height.....	178, 179
Variance Latitude .....	178, 179
Variance Longitude .....	178, 179
VDOP .....	179
Vertical Component of Velocity.....	175
VTG.....	84, 168
VTG Sentence.....	168
<b>W</b>	
W Pass.....	141
Windows 2000.....	18
Windows 95.....	18

Windows 98 ..... 18  
Windows NT..... 18  
Within MultiFix..... 20, 45, 48  
Work Area ..... 99  
W-Test ..... 139, 141

**X**

XP ..... 130, 137, 180, 184  
XP Offsets..... 137

**Y**

Yellow Box ..... 31

**Z**

Z Family ..... 20  
zer ..... 57  
Zero..... 8, 9, 82, 176  
Zero Application Resume..... 8  
Zero Log..... 55  
Zero Suite..... 9, 12, 82  
Zero Suite Programs..... 9  
ZEROLINK..... 82, 164, 176  
zpo ..... 12

